

# QUICKIE®

*Quickie*® Xtender

*User*

*Instruction*

*Manual &*

*Warranty*

**I. INTRODUCTION**

**A. FOREWORD**

Congratulations on your purchase of the Quickie Xtender. The Quickie Xtender is driven with the handrims just like every other hand operated wheelchair, but the Quickie Xtender’s power drive function will change how the wheelchair feels to the rider. Improper use of a wheelchair can, depending on surface and traffic conditions, represent a potential risk of injury and cause damage to the wheelchair. In every case and prior to use, this handbook must be read carefully by the wheelchair user and the attendant, in order to ensure that the chair is used in safety and comfort.

**B. SUNRISE LISTENS**

Thank you for choosing a Quickie wheelchair. We want to hear your questions or comments about this manual, the safety and reliability of your chair, and the service you receive from your Sunrise supplier. Please feel free to write or call us at the address and telephone number below:

Sunrise Medical  
Customer Service Department  
7477 East Dry Creek Parkway  
Longmont, Colorado 80503  
(303) 218-4500 or (800) 333-4000

Be sure to return your warranty card, and let us know if you change your address. This will allow us to keep you up to date with information about safety, new products and options to increase your use and enjoyment of this wheelchair. If you lose your warranty card, call or write and we will gladly send you a new one.

**FOR ANSWERS TO YOUR QUESTIONS**

Your authorized supplier knows your wheelchair best, and can answer most of your questions about chair safety, use and maintenance. For future reference, fill in the following:

Supplier: \_\_\_\_\_

Address: \_\_\_\_\_

\_\_\_\_\_

Telephone: \_\_\_\_\_

Serial #: \_\_\_\_\_ Date/Purchased: \_\_\_\_\_

**II. TABLE OF CONTENTS**

<b>I. INTRODUCTION</b> .....	2
<b>II. TABLE OF CONTENTS</b> .....	3
<b>III. COMPONENT DESCRIPTION</b> .....	4
<b>IV. NOTICE– READ BEFORE USE</b> .....	5
<b>V. EMI (ELECTROMAGNETIC INTERFERENCE)</b> .....	6
<b>VI. GENERAL WARNINGS</b> .....	8
<b>VII. WARNINGS: COMPONENTS &amp; OPTIONS</b> .....	17
<b>VIII. TIPS FOR ATTENDANTS</b> .....	21
<b>IX. SET-UP, ADJUSTMENT &amp; USE</b> .....	22
<b>X. FOR SAFE USE</b> .....	23
<b>XI. OPERATING THE WHEELCHAIR</b> .....	25
A. Before Using the Wheelchair .....	25
B. From Starting to Stopping .....	26
C. After Using the Wheelchair .....	28
<b>XII. ASSEMBLING AND CHANGING THE WHEELS</b> .....	29
A. Dismantling the Wheels .....	29
B. Fitting the Wheels .....	30
<b>XIII. TRANSPORT</b> .....	31
<b>XIV. MAINTENANCE</b> .....	32
A. Inspection and Adjustment .....	32
B. Anti-Tip Tubes .....	32
C. Tire Pressure .....	33
D. Inspecting the Wheelchair Frame and Wheels .....	33
<b>XV. BATTERY</b> .....	34
A. Charging Environment .....	34
B. Fitting the Battery into the Charger .....	34
C. Charging Process .....	35
D. If a Problem Arises During Charging .....	36
E. Checking the Battery .....	37
F. When a Battery is Installed in the Charger .....	37
G. Reduction of Battery Capacity .....	38
H. Battery Malfunction Display .....	38
I. Ending the Charging Process .....	39
<b>XVI. TROUBLESHOOTING</b> .....	40
<b>XVII. STORAGE</b> .....	42
<b>XVIII. SPECIFICATIONS</b> .....	43
<b>XIX. SUNRISE LIMITED WARRANTY</b> .....	44

## III. COMPONENT DESCRIPTION

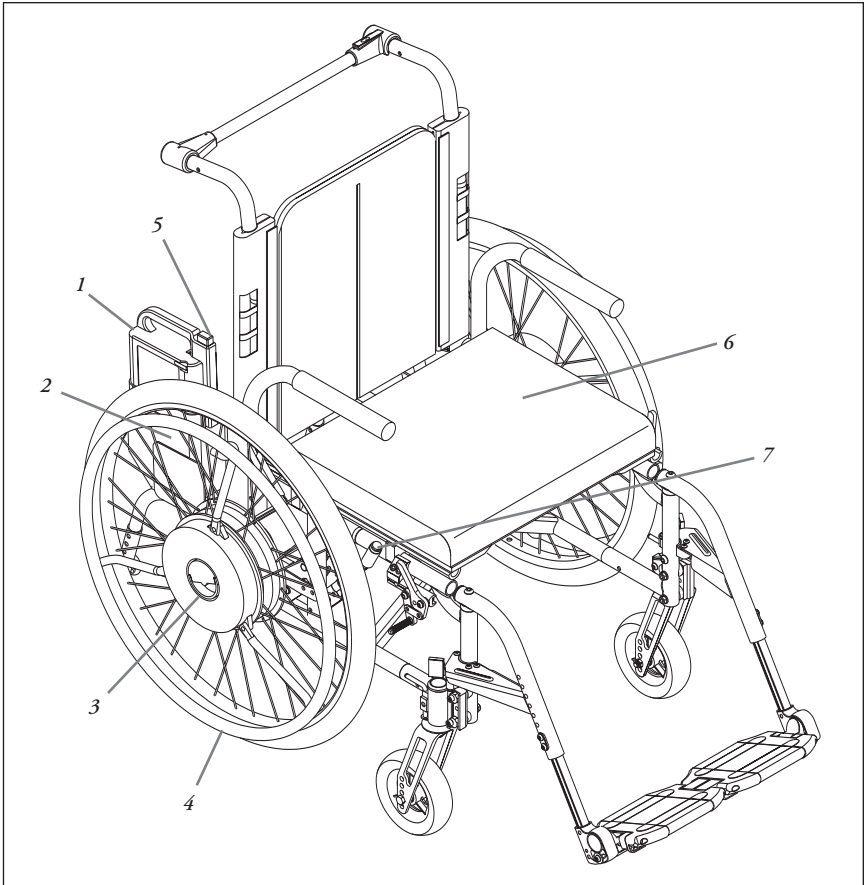

1. Battery
2. Battery compartment
3. Quick-release latch for the wheel
4. Torque sensing handrim
5. Battery release button
6. Quickie 2 manual wheelchair
7. ON/OFF switch
8. Charger (not shown)

**IV. NOTICE– READ BEFORE USE****A. CHOOSE THE RIGHT CHAIR & SAFETY OPTIONS**

Sunrise provides a choice of many wheelchair styles, sizes and adjustments to meet the needs of the rider. However, final selection of a wheelchair rests solely with you and your health care professional. Choosing the best chair for you depends on such things as:

1. Your size, disability, strength, balance and coordination.
2. Your intended use, and your level of activity.
3. The types of hazards you must overcome in daily use (in areas where you are likely to use your chair).
4. The need for options for your safety and comfort (such as positioning belts or special seat systems).

**B. ADJUST CHAIR TO YOUR ABILITY**

You need to work with your doctor, nurse or therapist, and your supplier, to fit this chair and adjust the controller settings for your level of function and ability level.

**C. REVIEW THIS MANUAL OFTEN**

Before using this chair you, and each person who may assist you, should read this entire Manual and make sure to follow all instructions. Review the warnings often, until they are second nature to you.

**D. WARNINGS**

The word “WARNING” refers to a hazard or unsafe practice that may cause severe injury or death to you or to other persons. The “Warnings” are in three main sections, as follows:

**1. VI. — EMI**

Here you will learn about electromagnetic interference and how it can affect your chair.

**2. VII — GENERAL WARNINGS**

Here you will find a safety checklist and a summary of risks you need to be aware of before you ride this chair.

**3. VIII — WARNINGS — COMPONENTS & OPTIONS**

Here you will learn about your chair. Consult your supplier and your health care professional to help you choose the best set-up and options for your safety.

**NOTE–** Where they apply, you will also find “Warnings” in other sections of this Manual.

## V. EMI (ELECTROMAGNETIC INTERFERENCE)

### WARNING

Heed all warnings to reduce the risk of unintended brake release or chair movement:

1. Beware of the danger from hand-held transceivers. Never turn on or use a hand-held transceiver while power to your chair is on. Use extra care if you believe that such a device may be in use near your chair.
2. Be aware of nearby radio or TV stations, and avoid coming close to them.
3. If unintended movement occurs, turn your chair off as soon as it is safe to do so.

### A. WHAT IS EMI?

#### WARNING

1. EMI means: electromagnetic (EM) interference (I). EMI comes from radio wave sources such as radio transmitters and transceivers. (A “transceiver” is a device that both sends and receives radio wave signals).
2. There are a number of sources of intense EMI in your daily environment. Some of these are obvious and easy to avoid. Others are not, and you may not be able to avoid them.
3. Powered wheelchairs may be susceptible to electromagnetic interference (EMI) emitted from sources such as radio stations, TV stations, amateur radio (HAM) transmitters, two-way radios, and cellular phones.
4. EMI can also be produced by conducted sources or electro-static discharge (ESD).

### B. WHAT EFFECT CAN EMI HAVE?

#### WARNING

1. EMI can cause your chair, without warning, to:
  - Move by itself
  - Move in unintended directions
 If any of these occurs, it could result in severe injury to you or others.
2. EMI can damage the control system of your chair. This could create a safety hazard, and lead to costly repairs.

### C. SOURCES OF EMI

#### WARNING

The sources of EMI fall into three broad types:

#### 1. Hand-Held Transceivers:

The antenna is usually mounted directly on the unit. These include: Citizens band (CB) radios, “Walkie-talkies”, security, fire and police radios, cellular phones, lap-top computers with phone or fax, and other personal communication devices.

**NOTE**– These devices can transmit signals while they are on, even if not in use.

## 2. Medium-Range Mobile Transceivers:

These include two-way radios used in police cars, fire trucks, ambulances and taxi cabs. The antenna is usually mounted on the outside of the vehicle.

## 3. Long-Range Transceivers:

These include commercial radio and TV broadcast antenna towers and amateur (HAM) radios.

**NOTE**– The following are not likely to cause EMI problems: Lap-top computers (without phone or fax), Cordless phones, TV sets or AM/FM radios, CD or tape players.

## D. DISTANCE FROM THE SOURCE

### WARNING

**EM energy rapidly becomes more intense as you get closer to the source.**

**For this reason, EMI from hand-held devices is of special concern. (See C.1)**

**A person using one of these devices can bring high levels of EM energy very close to your chair without you knowing it.**

## E. IMMUNITY LEVEL

### WARNING

1. The level of EM energy is measured in volts per meter (V/m). Every power wheelchair can resist EMI up to a certain level. This is called its “immunity level”.
2. The higher the immunity level, the less the risk of EMI. It is believed that a 20 V/m immunity level will protect the power wheelchair user from the more common sources of radio waves.
3. The configuration tested and found to be immune to at least 20 V/m is: Quickie Xtender power assist mounted to a Quickie 2 manual wheelchair.

### WARNING

**There is no way to know the effect on EMI if you add accessories or modify this chair. Any change to your chair may increase the risk of EMI. Parts from other suppliers have unknown EMI properties.**

## F. REPORT ALL SUSPECTED EMI INCIDENTS

### WARNING

**You should promptly report any unintended movement or brake release. Be sure to indicate whether there was a radio wave source near your chair at the time.**

**Contact: Sunrise Medical Customer Service Department at (800) 333-4000**

## VI. GENERAL WARNINGS

### WARNING

**Heed all warnings in this section. If you fail to do so a fall, tip-over or loss of control may occur and cause severe injury to you or others.**

#### A. NOTICE TO RIDER

### WARNING

1. Before using this chair, you should be trained in its safe use by your health care professional.
2. Every wheelchair is different. Take the time to learn the feel of this chair before you begin riding.
3. Be aware that you must develop your own methods for the safe use of this chair that are best suited to your level of function and ability.
4. Have someone help you practice bending, reaching and transferring until you learn how to do them safely.
5. Never try a new maneuver on your own unless you are sure it is safe.
6. Get to know the areas where you plan to use your chair. Look for hazards and learn how to avoid them.

#### B. NOTICE TO ATTENDANTS

### WARNING

**Make sure you heed all warnings and follow all instructions in each section of this manual. (Be aware that warnings that apply to the rider also apply to you).**

#### Notes:

1. You need to work with the rider, and the rider's doctor, nurse or therapist, to develop safe methods best suited to your abilities and those of the rider.
2. To manually push the chair you should turn the power off.
3. Propel this chair by the push handles only. They provide secure points for you to hold the rear of the chair to prevent a fall or tip-over.
  - Check to make sure push handle grips will not rotate or slip off.

#### Helping The Rider Overcome An Obstacle:

1. To prevent injury to your back, use good posture and proper body mechanics. When you lift or support the rider or tilt the chair, bend your knees slightly and keep your back as upright and straight as you can.
2. Before each maneuver, tell the rider what you plan to do, and explain what you expect the rider to do. This will put the rider at ease and reduce the risk of an accident.
3. Go straight up and straight down a curb or stair. If you turn, or climb or descend at an angle, a fall or tip-over is likely.
4. Remind the rider to lean back when you tilt the chair backward.
5. Lower the chair slowly. Do not let the chair drop to the pavement or ground. Doing so may damage the chair or injure the rider.

**C. WEIGHT LIMIT**** WARNING**

1. Never exceed a total rider weight of 250 lbs.
2. Never use this chair for weight training if the total weight (rider plus weights lifted) exceeds the indicated weight capacity of the wheelchair.
3. Exceeding the weight limit is likely to damage the seat, frame or fasteners and may cause severe injury to you or others from chair failure.
4. Exceeding the weight limit will void the warranty.

**D. EMI**** WARNING**

**Read Section V to learn about EMI. To reduce the risk of unintended brake release or chair movement:**

1. Never turn on or use a hand-held transceiver while power to your chair is on. Use extra care if you believe that such a device may be in use near your chair.
2. Be aware of nearby radio or TV stations, and avoid coming close to them.
3. If unintended movement or brake release occurs, turn your chair off as soon as it is safe.

**E. SAFETY CHECK-LIST**** WARNING**

**Before each use of this chair:**

1. Make sure the chair operates smoothly. Check for noise, vibration, or a change in ease of use. (They may indicate low tire pressure, loose fasteners, or damage to your chair).
  - If you detect a problem, make sure to repair or adjust the chair. Deferring repair or adjustment could increase the risk for injury. Your supplier can help you find and correct the problem.
2. Make sure batteries are charged. Green lights on battery charge indicator will light up when charge is full.

**F. CHANGES & ADJUSTMENTS**** WARNING**

**Never use non-Quickie parts or make a changes to your chair unless authorized by Sunrise. (Doing so will void the Warranty, and may create a safety hazard).**

1. If you modify or adjust this chair it may increase the risk of a fall or tip-over.
2. Modifications unauthorized by Sunrise constitutes remanufacturing of the wheelchair. This voids the warranty. The rider then assumes all future liability for the wheelchair.

**G. WHEN SEATED IN A PARKED WHEELCHAIR****⚠ WARNING**

1. Always turn off all power to your chair when you are parked, even for a moment. This will prevent:
  - Accidental movement from contact with the handrim.
  - Unintended movement from EMI sources.
2. Make sure that persons who help you (for example, store clerks) are aware of the joystick and do not touch it. If they do, your chair may move suddenly when you do not expect it.

**H. ENVIRONMENTAL CONDITIONS****⚠ WARNING**

**Your chair is not designed for use in a heavy rain storm, or in snowy or icy conditions.**

1. Contact with water or excessive moisture can cause an electrical malfunction. The frame, motors and other chair parts are not water-tight and may rust or corrode from the inside. To avoid a chair failure:
  - Minimize exposure of your chair to a rain storm or very wet conditions.
  - Never take your chair into a shower, tub, pool or sauna.
  - Do not use your chair in fresh or salt water (such as at the edge of a stream, lake, or ocean).
  - Make sure all electrical connections are secure.
  - Dry the chair as soon as you can if it gets wet, or if you use water to clean it.
2. Proceed slowly and use extra care if you must operate your chair on a wet or slick surface.
  - Do so only if you are sure it is safe.
  - Stop if one or both main wheels lose traction. If this occurs, you may lose control of your chair or fall.
  - Never operate your chair on a slope or ramp if there is snow, ice, water or oil film present.
  - When in doubt, have someone help you.
3. When not in use, keep your chair in a clean, dry place.

**⚠ WARNING**

**Extra caution should be used when employing the disc switch or the proximity head array as control devices. These two devices are susceptible to malfunction when wet.**

**I. TERRAIN****⚠ WARNING**

1. This chair is designed for use on firm, even surfaces such as concrete, asphalt and indoor flooring.
2. Do not operate your chair in sand, loose soil or over rough terrain. Doing so may damage wheels, bearings, axles or motors, or loosen fasteners.

## J. STREET USE

### WARNING

**In most states, power chairs are not legal for use on public roads. Be alert to the danger of motor vehicles on roads or in parking lots.**

1. At night, or when it is hard to see, use reflective tape on your chair and clothing.
2. It may be hard for drivers to see you. Make eye contact with drivers before you proceed. When in doubt, yield until you are sure it is safe.

## K. MOTOR VEHICLE SAFETY

Identify whether your chair has been manufactured with the Transit Option installed.

### WARNING

If your chair is NOT equipped with the Transit Option:

1. NEVER let anyone sit in this chair while in a moving vehicle.
  - a. ALWAYS move the rider to an approved vehicle seat.
  - b. ALWAYS secure the rider with proper motor vehicle restraints.
2. In an accident or sudden stop the rider may be thrown from the chair. Wheelchair seat belts will not prevent this, and further injury may result from the belts or straps.
3. NEVER transport this chair in the front seat of a vehicle. It may shift and interfere with the driver.
4. ALWAYS secure this chair so that it cannot roll or shift.
5. Do not use any chair that has been involved in a motor vehicle accident.

## L. CENTER OF BALANCE

### WARNING

**The point where this chair will tip forward, back, or to the side depends on its center of balance and stability.**

**The Center Of Balance Is Affected By:**

1. The seat height and seat angle.
2. A change in your body position, posture or weight distribution.
3. Using this chair on a ramp or slope.
4. The use of a back pack or other options, and the amount of added weight.

**To Reduce The Risk Of A Fall Or Tip-Over:**

1. Consult your supplier for information on modifications authorized by Sunrise before you modify or adjust this chair.

**NOTE**– You may need to make additional changes to correct the center of balance.

2. Use extreme care until you know the balance points of this chair and how to avoid a fall or tip-over.

## M. TRANSFERS

### WARNING

**It is dangerous to transfer on your own. It requires good balance and agility. Be aware that there is a point during every transfer when the wheelchair seat is not below you. To avoid a fall:**

1. Always turn off power before you transfer to or from your chair. If you fail to do so you may touch the handrim and cause your chair to move when you do not expect it.
2. Make sure wheel locks are engaged. This keeps the chair from moving when you transfer.
3. Work with your health care professional to learn safe methods.
  - Learn how to position your body and how to support yourself during a transfer.
  - Have someone help you until you are sure you can do a safe transfer on your own.
4. Move your chair as close as you can to the seat you are transferring to. If possible, use a transfer board.
5. Rotate the front casters until they are as far forward as possible.
6. Be careful of the footrests. If you can, remove or swing them out of the way.
  - Never stand on footrests when you transfer. Doing so may damage them or cause your chair to tip.
  - Make sure your feet do not “hang up” or get caught in the space between the footrests.
7. Make sure armrests do not interfere.
8. Transfer as far back onto the seat surface as you can. This will reduce the risk that you will miss the seat or fall.

## N. REACHING OR LEANING

### WARNING

**Reaching or leaning affects the center of balance of your chair. If done improperly, a fall or tip-over is likely. When in doubt, ask for help or use a device to extend your reach.**

#### **To Reduce the Risk of injury and/or Damage to the Chair:**

1. Never reach or lean if you must shift your weight sideways or rise up off the seat.
2. Never reach or lean if you must move forward in your seat to do so. Always keep your buttocks in contact with the backrest.
3. Never reach with both hands (you may not be able to catch yourself to prevent a fall if you lose your balance).
4. Never try to pick up an object from the floor by reaching down between your knees.
5. Never put pressure on the footrests while reaching. This may cause the chair to tip if you lean too far.
6. Never reach or lean over the top of the seat back. This may damage the backrest and cause you to fall.

**If You Must Reach Or Lean; Do So at Your Own Risk.****Remember to:**

1. Move your chair as close as you can to the object you wish to reach.
2. Rotate the front casters until they are as far forward as possible. This makes the chair more stable.

**NOTE**– To do this: Move your chair past the object you want to reach, then back up alongside it. Backing up will rotate the casters forward.

3. Turn off all power to your chair. If you fail to do so, you may touch the handrails and cause your chair to move when you do not expect it.
4. Firmly grasp a rear wheel or an armrest with one hand. This will help to prevent a fall if the chair tips.

**O. DRESSING OR CHANGING CLOTHES**** WARNING**

**Be aware that your weight will shift if you dress or change clothes while seated in this chair. To make the chair more stable, rotate the front casters until they are forward.**

**P. OBSTACLES**** WARNING**

**Obstacles you may have to overcome in daily use include door thresholds, lifts, ramps and hazards such as potholes and broken pavement. These can damage your chair and may cause a fall, tip-over or loss of control.**

1. Be aware that thresholds are very dangerous. (Even a small change in height may stop a caster wheel and cause your chair to tip). You may need to:
  - Remove or cover threshold strips between rooms.
  - Install a ramp at entry or exit doors.
2. Keep your eyes moving when you ride; scan the area well ahead of your chair.
3. Make sure the floor areas where you use this chair are level and free of obstacles.
4. To help correct your center of balance:
  - Lean your upper body forward slightly as you go up over an obstacle.
  - Press your upper body backward as you go down from a higher to a lower level.

**Q. DRIVING IN REVERSE**** WARNING**

**Use extra care when you drive your chair in reverse. You may lose control or fall if one of the rear wheels hits an object.**

1. Operate your chair slowly and at an even speed.
2. Stop often and check to make sure your path is clear of obstacles.

**R. RAMPS, SLOPES & SIDEHILLS**** WARNING**

**The center of balance of your chair changes when you are on a slope.**

**NOTE**– “Slope” includes a ramp or sidehill. Your chair is less stable when it is at an angle. Never use this chair on a slope unless you are sure it is safe. When in doubt, have someone help you.

**Beware Of:**

1. Steep slopes. Do Not use this chair on a slope steeper than 10%. (A 10% slope means: One foot in elevation for every ten feet of slope length).
2. Wet or slippery surfaces (such as when ice, snow, water or oil film is present). A loss of traction may cause a fall or tip-over.
3. A change in grade on a slope (or a lip, bump or depression). These may cause a fall or tip-over.
4. A drop-off at the bottom of a slope. (A drop-off of as small as 3/4 inch can stop a front caster and cause the chair to tip forward).

**S. TO REDUCE THE RISK OF A FALL, TIP-OVER OR LOSS OF CONTROL:**** WARNING**

1. Never use your chair on a slope unless you are sure you can do so without losing traction.
2. Always go as straight up and as straight down as you can.
  - Do not “cut the corner” on a slope or ramp.
  - Do not turn or change direction on a slope.
3. Always stay in the center of the ramp. Make sure ramp is wide enough that you are not at risk that a wheel may roll off the side.
4. Lean or press your body uphill. This will help adjust for a change in the center of balance caused by the slope.
5. Keep your chair moving at a slow, steady speed. Keep control over the chair at all times.
  - On a descent, do not let your chair accelerate beyond its normal speed.
  - If the chair picks up speed, slow the chair by pulling back on the handrims.

**NOTE**– The solid state controller of your chair has a logic system that will help control your speed when driving on a slope or up hill.

- If you stop, re-start slowly.
6. Never use rear wheel locks to try to slow or stop your chair. This is likely to cause the chair to veer out of control.

## T. RAMPS AT HOME & WORK

### WARNING

**Make sure ramps meet all Building Codes for your area.**

1. For your safety, have a licensed contractor build or remodel ramp to meet all standards.
2. **NOTE**– The proper design will vary, depending on such things as: the length and height of the ramp; the need for an intermediate platform; landing size; doors, and the direction of swing, and; whether the ramp includes a turn or angle.

#### **At A Minimum:**

1. Open sides of ramp must have side rails to prevent your chair from going over the edge.
2. Slope must not be steeper than one inch in height for every one foot of slope length.
3. Ramp surface must be even, and have a non-skid surface.
4. You may need to add a section at the top or bottom to avoid a lip or drop-off.
5. Ramp must be sturdy. Add bracing if needed, so ramp does not “bow” when you ride on it.

## U. WHEELCHAIR LIFTS

### WARNING

**Wheelchair lifts are used in vans, buses, and buildings to help you move from one level to another.**

1. Always turn off all power to your chair when you are on a lift. If you fail to do so, you may touch the handrim by accident and cause your chair to drive off the platform. (Be aware that a “roll-stop” at the end of the platform may not prevent this).
2. Make sure there is not a lip or drop-off at the top or bottom of the platform. These may cause a fall or tip-over. When in doubt, have someone help you.
3. Always position the rider securely in the chair to help prevent falls while on a lift.
4. Avoid moving forward if a wheel is “hung up” on the lip of the ramp. Backup, reposition the caster for a more direct approach. And slowly try again.

**V. CURBS & SINGLE STEPS**** WARNING**

1. Your chair is not designed to drive up or down a curb or step more than two (2) inches high. Doing so may:
  - Result in a fall or tip-over.
  - Damage the frame, wheels, axles or other chair parts, or loosen fasteners.
2. To prevent a fall or tip-over, use wheelchair access ramps or have someone help you.
3. If you must climb or descend a curb or step alone do so at your own risk and use extreme care.
  - Go as straight up or straight down as you can. Never turn or climb or descend at an angle as a fall or tip-over is likely.
  - Proceed slowly, at a steady speed.
4. Make sure that persons who assist you review the “Tips For Attendants” and heed all warnings.

**W. STAIRS**** WARNING**

**Never use this chair to go up or down stairs, even with an attendant. Doing so is likely to cause a fall or tip-over.**

**X. ESCALATORS**** WARNING**

**Never take this chair on an escalator, even with an attendant. Doing so is likely to cause a fall or tip-over.**

**VII. WARNINGS: COMPONENTS & OPTIONS**** WARNING**

If you use parts or make changes not authorized by Sunrise it may create a safety hazard and will void the Warranty.

**A. ANTI-TIP LEVERS**** WARNING**

Never remove or alter anti-tip levers. They help keep your chair from tipping over backward in normal use. Make sure rubber rollers are in good condition.

**B. ARMRESTS**** WARNING**

Armrests detach and will not bear the weight of this chair.

1. Never lift this chair by its armrests. They may come loose or break.
2. Lift this chair only by non-detachable parts of the main frame.

**C. CUSHIONS & SLING SEATS**** WARNING**

1. Quickie sling seats, standard foam cushions, and other body supports, are not designed for the relief of pressure.
2. If you suffer from pressure sores, or if you are at risk that they will occur, you may need a special seat system or a device to control your posture.
  - Consult your doctor, nurse or therapist to find out if you need such a device for your well-being.

**D. FASTENERS**** WARNING**

Many of the screws, bolts and nuts on this chair are special high-strength fasteners. Use of improper fasteners may cause your chair to fail.

1. Only use fasteners provided by Sunrise.
2. If fasteners become loose, tighten them as soon as you can.
3. Over- or under-tightened fasteners may fail or cause damage to chair parts.
  - See "Set-Up, Adjustment, & Use", for proper torque settings.

**E. FOOTRESTS****⚠ WARNING**

1. At the lowest point, footrests should be **at least 2 1/2 inches** off the ground. If set too LOW, they may “hang up” on obstacles you can expect to find in normal use. This may cause the chair to stop suddenly and tip forward.
2. To avoid a trip or fall when you transfer:
  - Make sure your feet do not “hang up” or get caught in the space between the footrests.
  - Avoid putting weight on the footrests, as the chair may tip forward.
  - Remove or swing the footrests out of the way, if possible.
3. **Never** lift this chair by the footrests. Footrests detach and will not bear the weight of this chair. Lift this chair only by non-detachable parts of the main frame.

**F. ON/OFF SWITCH****⚠ WARNING**

1. **Never** use the ON/OFF switch to stop the chair **except** in an emergency. This may result in an **abrupt** stop, and may cause you to fall.
2. To slow your chair to a stop, pull back on the handrims.

**G. PNEUMATIC TIRES****⚠ WARNING**

**Proper inflation extends the life of your tires and makes your chair easier to use.**

1. Do not use this chair if any of the tires are under- or over-inflated. Check weekly for proper inflation level, as listed on the tire sidewall.
2. Low pressure in a tire may cause the chair to veer to one side and result in a loss of control.
3. An over-inflated tire may burst.
4. **Never** use a gas station air pump to inflate a tire. Such pumps provide air at **high volume**, and could cause the tire to burst. To prevent tire damage:
  - Use a hand pump (or a **low volume** air pump) to inflate tires.
  - Use a tire gauge to check pressure.
5. Driving over sharp objects may cause damage to pneumatic tires and tubes.

**NOTE**– Use of airless inserts is not recommended and will void the warranty.

## H. POSITIONING BELTS (OPTIONAL)

### WARNING

**Use a positioning belt only to help support your posture. Improper use of such belts may cause severe injury or death.**

1. Make sure you are not at risk to slide down in the wheelchair seat. If this occurs, you may suffer chest compression or suffocate due to pressure from the belt.
2. A pelvic wedge or a similar device can help keep you from sliding down in the seat. Consult your health care professional to find out if you need such a device.
3. The belt must be snug, but must not be so tight that it interferes with breathing. You should be able to slide your open hand, flat, between the belt and your stomach.
4. Make sure you can easily remove the belt in an emergency.
5. **Never** use a positioning belt:
  - In place of a motor vehicle seat belt. In an accident or sudden stop you may be thrown from the chair. A positioning belt will not prevent this, and further injury may result from the belt.
  - As a restraint. A restraint requires a doctor's order.
  - On a rider who is comatose or agitated.

## I. PUSH HANDLES

### WARNING

1. Push handles provide secure points for an attendant to propel and control the chair. This helps to prevent a fall or tip-over.
2. Check to make sure push handle grips will not rotate or slip off.

## J. REAR WHEEL LOCKS (OPTIONAL)

### WARNING

**If you request them, we will install rear wheel locks at Sunrise.**

1. Rear wheel locks are **not** designed to slow or stop a moving wheelchair. **Never** apply them when your chair is moving. Doing so may cause you to veer out of control.
  - Use wheel locks **only** to keep the rear wheels from rolling when your chair is at a complete stop.
2. Low pressure in a rear tire may cause the wheel lock on that side to slip and may allow the wheel to turn when you do not expect it.
3. Make sure lock arms embed in tires at least 1/8 inch when locked. If you fail to do so, the locks may not work.

**K. SEATING SYSTEMS****⚠ WARNING**

1. Use of a seating system not approved by Sunrise may alter the center of balance of this chair. This may cause a fall or tip-over.
2. **Never** change the seating system of your chair **unless** you consult your supplier first.

**L. UPHOLSTERY FABRIC****⚠ WARNING**

1. Replace worn or torn fabric of seat sling and seat back as soon as you can. If you fail to do so, the seat may fail and cause you to fall. Worn fabrics may increase the potential for a fire hazard.
2. Sling fabric will deteriorate with age and use. Look for fraying, thin spots, or stretching of fabric at rivet holes. Replace fabric as required.
3. "Dropping down" into sling seat will weaken fabric and result in the need to inspect and replace sling on a more frequent basis.
4. Be aware that washing may reduce flame retardation of the fabric.

**VIII. TIPS FOR ATTENDANTS****⚠ WARNING**

1. Persons who help a rider do one of the following tasks should review and heed the warnings “Notice to Attendants” and all warnings in this Manual for that task.
2. The “Tips” that follow are suggestions only. Be aware that you will need to learn safe methods best suited to the rider and to your abilities. Consult your health care professional for instructions.

**A. TO CLIMB A CURB OR SINGLE STEP****⚠ WARNING**

The following is one way to safely help a rider climb a curb or single step going forward:

1. Stay behind the chair.
2. Face the curb and tilt the chair up on the rear wheels so that the front casters clear the curb or step.
3. Move forward, placing the front casters on the upper level as soon as you are sure they are past the edge.
4. Continue forward until the rear wheels contact the face of the curb or step. Lift and roll the rear wheels to the upper level.

**B. TO DESCEND A CURB OR SINGLE STEP****⚠ WARNING**

The following is one way to safely help a rider descend a curb or single step going backward:

1. Stay at the rear of the chair.
2. Several feet before you reach the edge of the curb or step, turn the chair around and pull it backward.
3. Proceed carefully. Look over your shoulder and carefully step back until you are off the curb or stair and standing on the lower level.
4. Pull the chair toward you until the rear wheels reach the edge of the curb or step. Then allow the rear wheels to slowly roll down onto the lower level.
5. When the rear wheels are safely on the lower level, tilt the chair back to its balance point. This will lift the front casters off the curb or step.
6. Keep the chair in balance and take small steps backward. Be sure to look where you are going. Turn the chair around and gently lower front casters to the ground.

**IX. SET-UP, ADJUSTMENT & USE****1. Work Surface For Set-Up:**

Use a flat surface, such as a table, to assemble, adjust and check your chair. This makes the steps easier and helps ensure a correct set-up.

**2. Fasteners:**

- Many of the screws and bolts on this chair are special high-strength fasteners and may have special coatings.
- Many nuts are of the Nylock type. They have a plastic insert to help prevent loosening.
- **Only** use screws, bolts and nuts provided by Sunrise.

**⚠ WARNING**

- 1. Use of improper fasteners may cause the chair to fail.**
- 2. Over- or under-tightened fasteners may fail or cause damage to chair parts.**
- 3. If bolts or screws become loose, tighten them as soon as you can. Loose bolts or screws can cause damage to other chair parts causing them to fail.**

**3. Washers & Spacers:**

- Note the position of washers and spacers before disassembly.
- To avoid damage to the frame, replace all washers and spacers when you reassemble parts.

**4. Torque Settings:**

A torque setting is the optimal tightening for a particular fastener. Use a torque wrench that measures inch-pounds to secure screws, nuts and bolts on this chair.

**NOTE**– Unless otherwise noted, use a torque setting of 120 inch-pounds for all fasteners.

## X. FOR SAFE USE

### A. POWER DRIVE

The Quickie Xtender system comprises three different driving modes: "hand-driven operation", "Stand-By-Operation" and "Power assisted operation". The appropriate mode is obtained by operating the main switch or activating the handdrims. A Stop-Function\* operates when the handdrims are not activated when the main switch is on. The following overview illustrates comprehensively how the power assist system works.

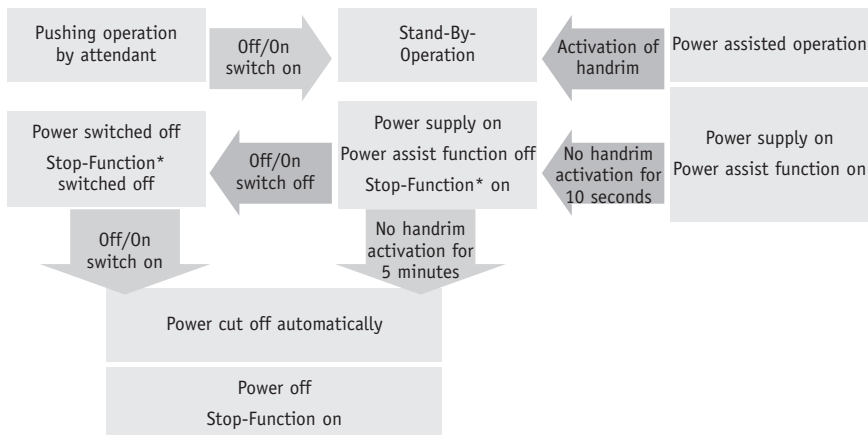

### B. PLEASE NOTE

#### **⚠ WARNING**

**Driving in the following places or environments can be dangerous. An attendant should always be present and special safety precautions should be observed.**

- Crossing railway lines. (The casters could get caught in the track.)
- On pavements with no distinct edging. (There is the danger of falling into the street.)
- On station platforms. (There is the danger of falling onto the track.)
- Over gratings for culverts or drains. (The casters could get stuck between the grating bars.)
- On gravel roads. (The tires could get stuck.)
- Traveling downhill. Travel downhill only with power supply switched on. (There is a great danger of the wheelchair travelling so quickly that you would not be able to stop it on your own.)
- On paths which force the wheelchair to lean to one side. (The wheelchair could tip over sideways.)
- Driving by night. (Unfamiliarity with the road surface could lead to tip-overs. Collisions with unseen third parties could occur.)
- Driving on hydraulic ramps. (There is the danger of falling off the ramp.)
- Other places which are unsuitable for wheelchair users or with which the wheelchair user is unfamiliar.

## **WARNING**

### **LOW BATTERY LEVELS**

**When the battery warning light flashes and you hear the "pip-pip-pip-pip", change the battery promptly. If you continue to use the power assist function and the battery is completely discharged, the battery warning light will be constantly illuminated and you will hear a "beep" tone. The power assist function will switch off. It is very dangerous to get into a situation where you are unable to continue to move. You must change to a replacement battery as follows.**

- First get your wheelchair to a safe place. Turn the power supply off and switch to the replacement battery. If you have no replacement battery with you, leave the power supply turned off while driving.
- If you cannot change the battery on your own, an attendant must be present.

If the battery warning light suddenly comes on and the power drive sounds the "beep" tone and stops, there may be a malfunction. Do not continue to use the power drive. Read the "Troubleshooting" section of this manual and contact your nearest dealer. (When the battery is empty, the warning light flashes first, and you can hear a "pip-pip-pip-pip" tone, before the power drive stops. In this instance the system is working normally).

## **WARNING**

**Do not lift the wheelchair by its handrims, the battery or the cable. This could cause damage, especially if the wheelchair and its passenger are lifted together, there is a risk of tipping over or falling out. Please observe the following:**

- Put the brakes firmly on both wheels so that they cannot turn.
- Switch off the power supply.
- Lift the wheelchair only by the frame.

## **WARNING**

**The battery on the Quickie Xtender is not very large but stores a large amount of charge. Improper use can cause damage or in certain circumstances lead to burns or fire.**

- When charging always use the charger supplied.
- When the battery is not in use, always fit the protective cap.
- Do not allow battery connection clamps to come into contact with wires or other metals.
- Do not expose the battery to any impact; do not remove parts of the battery or add others.
- Only use battery for the intended purpose.
- Do not expose the battery to heat or place in fire or water.
- Use the fuse provided.
- Do not use the battery if the housing shows signs of damage.
- Keep the battery out of reach of children and third parties.
- If the battery housing is damaged, a corrosive liquid (KOH) can be emitted. Avoid any contact with the skin.

## XI. OPERATING THE WHEELCHAIR

### **⚠ WARNING**

Improper use of the Quickie Xtender can, depending on the nature of the surface and the traffic conditions, lead to injury or damage to the wheelchair. It is advisable to read the information in "For safe driving" before starting out.

#### A. BEFORE USING THE WHEELCHAIR

1. Check the battery charge available by pressing the display switch (A) to show the capacity on the display diodes. Pressing the display switch lights up the diodes for several seconds.

- NOTE--**
- The remaining battery capacity is shown in a 5-step display (when new).
  - As the battery deteriorates the diodes will not light up, even when charging is finished (see "Troubleshooting"). Also its range is reduced.
2. Check that the anti-tip tubes are fitted and adjusted correctly (see Inspection and Setting).

### **⚠ WARNING**

Never use the wheelchair without anti-tip tubes! If the wheelchair is used without anti-tip tubes, or if the tubes are less than "standard length", there is the risk of tipping over. Never set off without first carrying out the relevant adjustments.

3. Sit in the wheelchair.  
If your position is wrong when getting into or out of the wheelchair, it can unexpectedly roll away, tip over or cause you to fall out.
4. Fit the battery with the power turned off. Fit the battery until you hear it click into place. **Do not drop the battery or subject it to impact, as this could lead to a malfunction.**

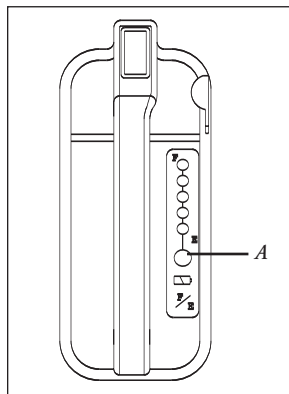

### **⚠ WARNING**

- Check that there are no foreign bodies in the battery holder. Remove any foreign body before fitting the battery.
  - Do not bend or damage any contact points.
5. Sit in the wheelchair properly, so that there is no danger of falling out.

### **B. FROM STARTING TO STOPPING**

1. Ensure that the brakes for both wheels are on.
2. Switch on power supply (A). The power drive is available as soon as the red light (B) goes out after the "pip" tone has sounded.

- NOTE–**
- If when you switch on, pressure is being exerted on the handrims, the warning "pip" sounds, the safety system is active and the wheelchair cannot be driven. Release your grip on the handrims and switch on again.
  - The battery is empty when the battery warning light is on or flashing. Change the battery and start again.
  - If the red battery warning light is on immediately after changing the battery, the wheelchair cannot be operated. There may be a fault in the system. Please contact your nearest dealer.
3. Both wheel locks off.
  4. Before using the wheelchair, make yourself familiar with the characteristics of the power drive. Drive safely.
  5. Always drive carefully, because using a wheelchair can be dangerous wherever you are driving.

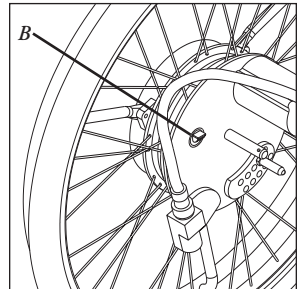
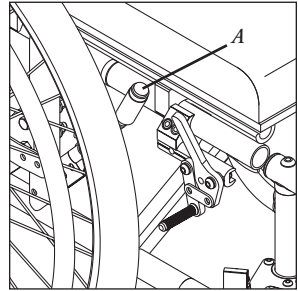

## WARNING

If the wheelchair is used without anti-tip tubes, or if the tubes are shorter than the "standard length", there is a risk that the wheelchair will tip over. Never set off until the relevant adjustments have been carried out.

- NOTE**–
- Moving the centre of gravity line towards the front reduces the danger of the wheelchair tipping up backwards.
  - Wheelchair users who have difficulty altering the centre of gravity should always have an attendant with them.
6. When driving, pay attention to the condition of the battery (battery warning lights and audible warning signals).  
When the battery indicator flashes and you hear a "pip-pip-pip-pip" tone, change the battery promptly. If you continue to use the power drive and the battery is completely empty, the battery warning light is constantly illuminated and a "beep" tone is emitted. The power drive switches off. It is very dangerous to get into a situation where you can no longer move. You must change to a replacement battery. (Follow the "Fitting the Battery into the Charger" instructions in the "Battery" section of this manual.)
7. Before removing the battery, switch off the power supply. Lift the battery up and at the same time press the release button. Fit the new battery, adjusting until you hear it click into place.  
Put the protective cap on the old battery immediately. Otherwise there is the danger of a short circuit if the connecting parts are not covered.
8. When you stop, activate the brakes with the handrims.

**IMPORTANT**– apply brakes to both rear wheels when stopping or parking on a sloping surface.

**NOTE**– to protect the battery, the power supply is automatically switched off when there is no activation of the handrim when in power drive mode for 5 minutes. A "Beep" tone is emitted. You must switch off before switching on again.

9. If the wheelchair is to be lifted by an attendant, e.g. to negotiate stairs, inform him/her of the parts by which the wheelchair is to be gripped.

The wheelchair must not be lifted by the handrims, the battery or the cable. This could cause damage. Especially when both wheelchair and driver are to be lifted, there is the danger that the wheelchair could tip over or the user could fall out. Please lift properly.

10. Mobile phones and radio equipment emit radio waves when in use. When you use such equipment, please observe the following instructions, so that the Quickie Xtender is not impaired by radio waves.

**IMPORTANT**–

- Stop your wheelchair on a safe surface and turn off your Quickie Xtender before using a mobile phone or similar equipment.
- Turn your mobile phone and similar equipment off, before operating your wheelchair with power drive.

**C. AFTER USING THE WHEELCHAIR**

1. Procedure for getting out of your wheelchair.

If your position is wrong when getting into and out of your wheelchair, it can unexpectedly roll away, tip over or cause you to fall out.

2. Keep your wheelchair in a safe place with the power switched off, when not in use.

** WARNING**

**For children or others who should not operate this wheelchair, contact with the wheelchair is very dangerous. Always place it out of the reach of third parties or remove the battery, when the wheelchair is not in use.**

3. After removing the battery, charge it for future use (see “Battery”).

## XII. ASSEMBLING AND CHANGING THE WHEELS

Observe the following guidelines when fitting and changing wheels (removable models).

### **⚠ WARNING**

**Do not let any portion of your hand extend past the wheel inner rim during wheel removal. The motor assembly can rotate in the wheel assembly and may create a pinch point.**

#### A. DISMANTLING THE WHEELS

1. Remove the battery (A), so that the power is not inadvertently switched on during the operation.

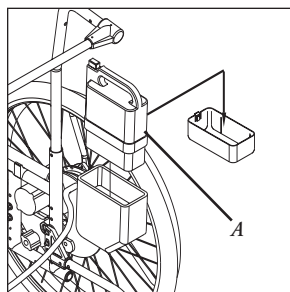

**NOTE-** Always place the protective cap on the battery when removed. There is the risk of a short circuit if connecting parts are not covered.

2. Take the coupler plug (B) out of the left wheel by turning the end a small amount.

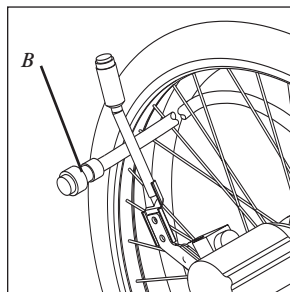

**NOTE-** Wind the coupler plug (B) you have removed onto the right wheel and take care that it is not damaged.

3. Open the quick-release axle clamp on the left wheel. Pull the lever and remove the rear wheel. (C)

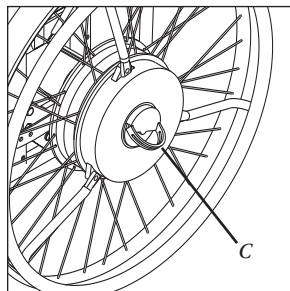

**NOTE-** When the left wheel has been removed, the wheelchair frame and the remaining right wheel are light enough to be carried. If it is not necessary to take off the right wheel, the wheelchair can then be lifted into a vehicle.

4. If necessary, the right wheel can be removed in the same way.

**IMPORTANT-** When removing the wheel, hold the battery holder firmly, so that the wheel does not turn. Under certain circumstances, if a wheel revolves during this operation, the battery holder and other parts may be damaged.

**B. FITTING THE WHEELS**

Open the quick-release axle clamp on the left wheel and place the axle in the adapter plate fitting, align the torque support and fit the wheel. (D). Fit the coupler plug of the electric connecting cable into the appropriate socket on the left drive. When plugging in, the white markings must be over each other.

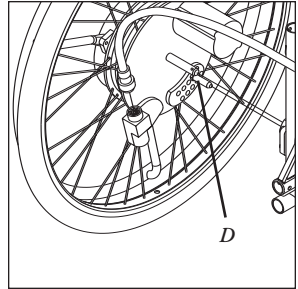

**XIII. TRANSPORT**

When loading the wheelchair into a vehicle, always follow the following guidelines:

1. Remove the battery, so that the current is not inadvertently switched on during transport.

**NOTE**– Always fit the protective cap on the battery you have removed. If the connecting parts are not covered, there is the risk of a short circuit.

2. Apply the wheel locks to both wheels, so that they cannot revolve.
3. Fold the wheelchair together and do not trap the cable.

**NOTE**– • Flip up footplates.

- Grasp the seat upholstery at the front and back and pull upwards. Fold in handles.

4. Hold the wheelchair frame firmly with both hands and lift into the vehicle.

**NOTE**– Do not lift the wheelchair by its handrims, the battery or the cable. This could cause damage.

5. During transport, place a cushion or something similar under the wheelchair so that it does not rattle.
6. After transporting, set up the wheelchair again by reversing the steps above.

**IMPORTANT**– do not place hands or fingers beside or under the seat tube.

**NOTE**– Transit option not available with Xtender power assist.

**NOTE**– Transit option should not be added to any wheelchair with the Xtender.

## XIV. MAINTENANCE

Please observe the following.

1. Store the wheelchair with the battery removed.

### WARNING

**For children and others who should not operate this wheelchair, contact with it can be very dangerous. Always remove the battery when the wheelchair is not in use.**

**NOTE**– When not in use, the battery should be recharged every three months to ensure optimum performance after being stored.

2. If the wheelchair has become wet, wipe it dry with a cloth to prevent corrosion.
3. Wipe off dirt or marks with a well wrung-out cloth.

**IMPORTANT**– never spray water directly onto the wheelchair. This could cause the electrical parts to malfunction.

4. Keep the wheelchair indoors to avoid damp.

**IMPORTANT**– do not store the wheelchair anywhere where it is exposed to rain, direct sunlight or high humidity. This could lead to malfunction.

5. Do not keep the battery where it is exposed to high temperatures.

**IMPORTANT**– do not leave the battery in the car for long periods, where the effect of the sun is strong.

### A. INSPECTION AND ADJUSTMENT

If the wheelchair is used without anti-tip tubes, or if the tubes are shorter than the “standard length”, there is a risk that the chair will tip over. Never set off until you have carried out the appropriate adjustments.

### B. ANTI-TIP TUBES

1. To adjust the anti-tip tube, push in the pin and adjust the tube bar. This has engaged when the pin comes out again with an audible “click”.
2. Check that the clearance between the raised casters and the ground is between 1" and 2", when the anti-tip wheel touches the ground. If the clearance is too large or too small, slot the tube bar into one hole further forwards or back.

**C. TIRE PRESSURE**

The effectiveness of both the knee lever brake and the general driving performance depend on air pressure. With properly inflated rear wheels and equal pressure in both tires, your wheelchair can be maneuvered more efficiently and easily.

**D. INSPECTING THE WHEELCHAIR FRAME AND WHEELS**

Use of the wheelchair with irregularities in the frame or wheels can lead to sudden damage to the wheelchair and consequently to tipping over or imbalance.

Always monitor the condition of your wheelchair components. If you identify any irregularities, take your wheelchair to your dealer for inspection and repair.

- Fracture in frame.
- Loosening in connection of components.
- Loose or broken spokes.
- Effectiveness of brakes.
- Casters out of shape.
- Worn tires.

## XV. BATTERY

Although the battery on the Quickie Xtender is very compact, it can store a large amount of power. Faulty handling can damage the equipment and in some cases can result in burns or fire.

### A. CHARGING ENVIRONMENT

For charging, select an area which meets the following requirements:

- room at normal temperature, not subject to large variations in temperature.
- flat and stable floor space

### Avoid the following environments when charging a battery:

- rooms with excessive temperatures, e.g. with direct sunlight or close proximity to a stove. Also rooms in which the temperature falls below freezing, e.g. unheated rooms in winter.

*Charging cannot begin if the battery temperature is too high or too low.*

- Damp places, e.g. outside in the rain or near a wash basin.  
*There is the risk of a short circuit or an electric shock.*
- Areas where objects can be placed on or near the charger.  
*During charging the charger can heat up and consequently not function properly.*
- Areas where small children or household pets could come into contact with the charger.

*There is the risk that they may get hurt and/or that the equipment will be damaged.*

### B. FITTING THE BATTERY INTO THE CHARGER

For charging, use no other equipment than the authorized charger. There is the risk of causing a fire or the possibility that the battery could be damaged.

1. Use the connecting cable supplied to connect the charger to the power supply.
2. The battery you want to charge should be at an appropriate temperature between 10°F and 105°F.

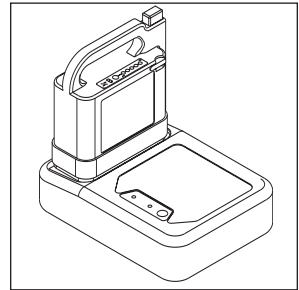

**IMPORTANT–** to protect the battery, only start charging when a battery which is too warm has cooled down to the temperature given. As the battery will heat up straightaway when the wheelchair has been used on a warm summer day, it must be cooled down to an appropriate temperature before charging.

3. Push the battery carefully into the battery housing until it touches the bottom. Do not jolt or drop the battery, as this can lead to a malfunction.

### IMPORTANT–

- Do not place your hand or any object on the battery housing contacts in the charger.
- Check for foreign bodies in the battery housing and remove them.
- Do not bend or damage the charger contacts.

### C. CHARGING PROCESS

The battery can be charged in two ways. One way is a "Quick-charge", where charging occurs over a short period of time (2-3 hours), and the other is the "Refresh-charge", which "reactivates" the battery.

To achieve a long battery life in the Quickie Xtender, and to avoid a reduction in the capacity, you should carry out the "Refresh process" when indicated. When this charging method is necessary, the indication will appear in the LED "refresh" display via the charger.

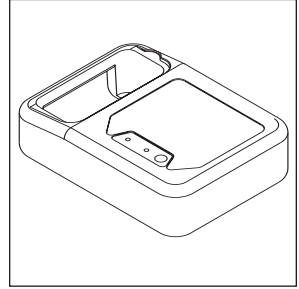

#### 1. Quick-charge

1. Place the battery in the charger. When the battery is at the correct temperature the charger display illuminates (green) and charging begins. Charging takes 2 to 3 hours (at higher temperatures charging can take longer).
2. If the battery temperature is too high (over 105°F) or too low (below 40°F), the charging light flashes (green) until the battery is at the accepted temperature. If the temperature is correct, the charging light illuminates (green) and charging begins automatically. Although the standby-time varies depending on the temperature conditions, this lasts app. 1 to 2 hours.
3. The progress of recharging is shown on the battery capacity display. The indicators serve as a guide for the time up to the completion of the charging process.
4. When charging is complete, you will see the green charging light and the battery capacity display disappear.

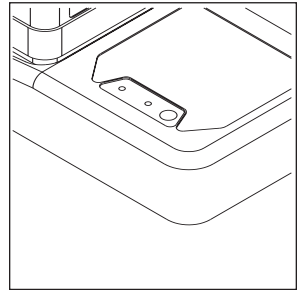

**IMPORTANT**— do not press the Refresh-key during the first 3 charging cycles! Ignoring this warning will prevent the battery from reaching full capacity.

#### 2. "Refresh" charging

When refresh charging, discharge and charging occur automatically.

During complete discharging and consequent recharging of the nickel-/metal hydride battery, the battery cells are revitalized, preventing a reduction in the charging capacity.

1. Place the battery in the charger.
2. The flashing yellow Refresh Light on the charger indicates the necessity for the refresh charging process (app. 10 seconds). If the Refresh Button is pressed promptly, the Refresh LED display lights up and the refresh charging process begins.

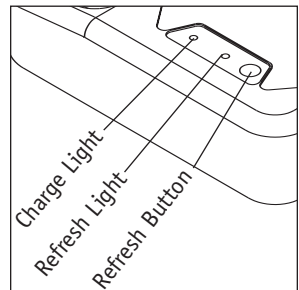

- During charging the battery capacity display shows the progress of the refresh procedure in the battery. The time required will vary according to the capacity of the battery (9-12 hours).

#### D. IF A PROBLEM ARISES DURING CHARGING

If a problem occurs in the battery or in the charger during charging, this is indicated by the alternate flashing charge displays (green) and (yellow) on the Refresh display on the charger and/or on the battery capacity display.

#### The displays on the charger and the charger Refresh display flash simultaneously.

This indicates an internal malfunction in the battery. Please replace the battery with a new one.

#### The fourth LED on the battery capacity display flashes.

This indicates an internal malfunction in the battery. Please replace it with a new one.

#### The charge display and the refresh display on the charger flash rapidly (in 1-second intervals), and the third LED on the battery capacity display flashes.

- The contacts may be malfunctioning. Please check if small objects have broken the electrical contact between the battery terminals and those of the charger, and remove them. If there is dirt or dust on the contacts, remove it with a dry cloth, ensuring that the contacts are not bent or damaged
- The battery fuse may have blown. Open the fuse cover (A) on the side of the battery and check the fuse. If the fuse is damaged, fit the replacement fuse which is located on the protective cap.

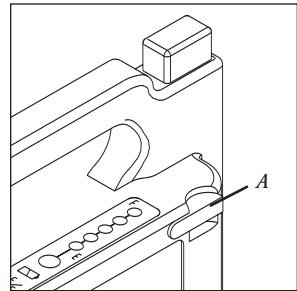

### **⚠ WARNING**

**There is a fire risk if the authorized fuse (20 A fuse) is not used. Do not use any other. Never use wire instead of the authorized fuse.**

#### The first, third and fifth LED on the battery capacity display will flash.

The battery is not at the correct temperature for charging. Wait until the battery is at a suitable temperature and begin the charging process.

#### The charging lights and the refresh lights flash alternately in a slow sequence (2-second intervals).

The charger is faulty. Replace it with a new one and carry out the charging process.

## **E. CHECKING THE BATTERY**

The battery capacity is shown when the display key is pressed. The total capacity is indicated on the LEDs in increments of 20%.

The display is active for app. 5 seconds.

### **1. Reading the display**

If the battery is used constantly from a fully charged state, the number of illuminated LEDs is reduced one by one.

The remaining capacity of the battery is displayed.

### **2. Timing of charging**

The battery capacity is low. Charging should take place soon. (Operation is still possible for a while).

### **3. Charging should begin now.**

The remaining battery capacity is very low. Using the power assist drive is only possible for a short distance. Get the wheelchair to a safe place and change the battery or charge it immediately.

**IMPORTANT**– When changing the battery make sure the brakes are engaged on both wheels.

## **F. WHEN A BATTERY IS INSTALLED IN THE CHARGER**

### **1. During a quick-charge**

- When the charging process starts, the capacity display is automatically activated and indicates the progress of the charging process.
- At the end of the charging process the capacity display automatically goes out.

#### **Reading the display**

Permanently illuminated LEDs indicate the level of charging capacity. A flashing LED shows that charging is in progress.

Full capacity has almost been reached. Charging will shortly finish.

### **2. During Refresh-charging**

- When Refresh-discharging begins, the capacity display LEDs go out one after another. Discharging the battery reduces its capacity to zero.
- When the Refresh-discharge is complete, charging begins automatically. The display now changes to quick-charge mode.

#### **Reading the display**

The flashing LED on the capacity display indicate the remaining capacity of the battery.

The Refresh-discharge process will soon be complete and the charger switches to charge. Charging will be complete in app. 4 to 6 hours.

## G. REDUCTION OF BATTERY CAPACITY

If you press the display key and not all the LEDs on the battery capacity display are illuminated after charging, this shows that the battery capacity is reduced.

Depending on the condition of the battery, the capacity display can return to maximum with successive charging processes.

### **Battery status:**

Battery capacity is reduced to 60 to 80%. Sufficient for normal use of power drive.

### **Verdict:**

The battery capacity is reduced in comparison to that of a new one. Replacement with a new battery is necessary, if you want to travel a long way on only one battery charge.

### **Battery status:**

The battery is capable of storing at most 60% of its original capacity. Adequate use of the power drive is no longer possible.

### **Verdict:**

Replace the battery with a new one. Time for replacement.

- NOTE**–
- Depending on the condition of the battery, the capacity display can return to the original maximum capacity following successive charges.
  - Contact your dealer when no more than 3 LEDs on the capacity display light up after the charging process.

## H. BATTERY MALFUNCTION DISPLAY

If there is an internal malfunction in the battery or if the battery temperature lies outside the acceptable range, information regarding battery status will appear on the battery capacity display.

### **Internal battery malfunction**

- The fourth LED flashes: please contact your dealer.
- Although charging cannot be carried out, it is possible to use the battery until it is completely discharged.

**Unsuitable battery temperature**

- The first, third and fifth LEDs flash. Although it is possible to use the battery, we recommend that you do not operate the wheelchair until the temperature has returned to the normal range. Remaining battery capacity will not appear in the display.
- If the battery has reached a suitable temperature, lights 1, 3 and 5 stop flashing and the battery capacity is shown again.

**Battery fuse blown or contact error**

LED 3 flashes. See the “Troubleshooting” section for details about problems arising during charging under the header “Charging”.

**I. ENDING THE CHARGING PROCESS**

1. Remove the charged battery after completing the charging process. Remember to replace the protective cap on the battery before storing it. Unprotected contacts can lead to a short circuit.
2. Remove the plug from the socket.

**IMPORTANT**– Do not pull by the cable itself as this could cause damage.

3. Long-term storage of the battery.  
Long-term storage of the battery reduces its capacity through spontaneous discharge. Fully charge the battery before you store it long-term and avoid rooms where the temperature is too high.
4. Recycling the battery  
A battery which has reached the end of its life and which cannot be used any longer, is still a resource of valuable material.

## XVI. TROUBLESHOOTING

If there is a problem with the Quickie Xtender, please check the following points before commissioning any repairs.

PROBLEM	CHECK	ACTION
<b>SERVICE OPERATION</b>		
<b>Manual operations is difficult to carry out.</b>	<ol style="list-style-type: none"> <li>1. Does the battery indicate a low status?</li> <li>2. Is the battery fitted properly?</li> <li>3. Did the on/off switch work while pressure was applied to the handrim?</li> <li>4. Was the on/off switch automatically turned off by the automatic switch-off function?</li> </ol>	<ol style="list-style-type: none"> <li>1. Charge or replace the battery.</li> <li>2. Install the battery correctly.</li> <li>3. Switch off the on/off switch and then switch on again.</li> <li>4. If the problem persists, contact your dealer.</li> </ol>
<b>Unusual vibration.</b>	<ol style="list-style-type: none"> <li>1. Is the adapter plate loose?</li> <li>2. Is the power unit making a strange noise?</li> </ol>	<ol style="list-style-type: none"> <li>1. Tighten up again.</li> <li>2. Please contact your dealer.</li> </ol>
<b>Restricted operational range.</b>	<ol style="list-style-type: none"> <li>1. Is the battery completely charged?</li> </ol>	<ol style="list-style-type: none"> <li>1. Carry out a Refresh charge or replace the battery.</li> </ol>
<b>MANUAL OPERATION</b>		
<b>Manual operation is difficult.</b>	<ol style="list-style-type: none"> <li>1. Is there sufficient tire pressure?</li> </ol>	<ol style="list-style-type: none"> <li>1. Pump up the tires.</li> </ol>

PROBLEM	CHECK	ACTION
<b>CHARGING</b>		
<b>Battery does not charge.</b>	<ol style="list-style-type: none"> <li>1. Is the power cable connected?</li> <li>2. Is the battery fuse OK?</li> <li>3. Is the ambient temperature satisfactory for the charger?</li> </ol>	<ol style="list-style-type: none"> <li>1. Connect power cable.</li> <li>2. Replace fuse.</li> <li>3. Charge in an area with suitable temperature.</li> </ol>
<b>Battery capacity display fails to light up even after charging.</b>	<ol style="list-style-type: none"> <li>1. Is the ambient temperature suitable for the charger and the battery?</li> </ol>	<ol style="list-style-type: none"> <li>1. Try charging again after having waited until the temperature is suitable for the battery and the charger. If all the LEDs on the battery capacity display do not light up after another attempt at charging, the capacity of the battery is reduced due to its age.</li> </ol>
<b>Charging process ends immediately.</b>	<ol style="list-style-type: none"> <li>1. Is the battery completely full?</li> </ol>	<ol style="list-style-type: none"> <li>1. Check the capacity using the battery capacity display.</li> </ol>
<b>Charging takes a long time.</b>	<ol style="list-style-type: none"> <li>1. Is the ambient temperature, battery temperature and charger temperature normal?</li> </ol>	<ol style="list-style-type: none"> <li>1. Wait until the temperature is satisfactory.</li> </ol>
<b>Charger becomes unusually warm.</b>		<ol style="list-style-type: none"> <li>1. Please contact your dealer.</li> </ol>
<b>Unusual noise or smell.</b>		<ol style="list-style-type: none"> <li>1. Please contact your dealer.</li> </ol>

**XVII. STORAGE**

Please observe the following points with regard to storage.

1. Remove the battery before storing.

It can be very dangerous for a child or anyone unfamiliar with the operating methods to carry out this procedure. Ensure that the battery is removed from the wheelchair when not in use. Ensure that the protective cap is in place before the battery is stored. If the contacts are unprotected there is the risk of a short circuit.

**NOTE**– When not in use, the battery should be recharged every three months to ensure optimum performance after being stored.

2. After operating the wheelchair on wet ground, wipe off any drops of water with a dry cloth. Wet equipment can rust.
3. To remove mud and dirt, rub off with a well wrung-out cloth.

**IMPORTANT**– Never bring into contact with water, as this can cause an electrical malfunction.

4. Storage in rooms with low humidity.

**IMPORTANT**– Avoid storage areas where the equipment can get wet or where it is exposed to direct sunlight or excessive humidity, as this can lead to a malfunction.

5. Avoid rooms where the temperature is too high for storing the battery.

**IMPORTANT**– do not leave the battery for long periods in the car in warm weather!

**XVIII. SPECIFICATIONS**

**A. QUICKIE XTENDER**

Power drive specification.....	1.5X Torque multiplier 3X Torque multiplier
Weight.....	37 lbs.
Operational range after one charge*.....	up to 9 miles*
Drive system.....	Wheel hub motor, direct rear wheel drive
Steering system.....	Handrim activation, right and left
Tire size.....	24 x 1 3/8
Ambient operating temperature.....	23°F to 105°F
Storage temperature.....	-4°F to 140°F
maximum load.....	250 lbs

**B. CHARGER**

Electrical requirements.....	Alternating current 100 to 220 V, 50/60 Hertz
Total output.....	150 W
Battery.....	Nickel-metal hydride (NiMh) 24 V x 6.7 Ah, 30 A plug-in fuse
Charging time.....	Quick-charge process 2-3 hours Refresh-charging 9-12 hours
Ambient temperature for charging.....	40°F to 105°F

\*Operational range will vary greatly depending on the surface and the driving conditions. In this case the conditions are as follows: 24 inch wheel diameter/full battery (new)/normal temperature of 77°F/steady driving on a flat, level surface/driving at a wheelchair speed of 3 mph.

**A. FOR TWO (2) YEARS**

Sunrise warrants the Quickie Xtender against defects in materials and workmanship for two (2) years.

**B. FOR ONE (1) YEAR**

Sunrise warrants the Quickie Xtender battery against defects for one year from the date of first consumer purchase.

**C. LIMITATIONS**

1. We do not warrant damage due to:
  - Neglect, misuse or improper installation or repair.
  - Use of parts or changes not authorized by Sunrise.
  - Exceeding weight limit of 250 pounds.
2. This warranty applies in the USA only. Check with your supplier to find out if international warranties apply.

**D. WHAT WE WILL DO**

Our sole liability is to repair or replace covered parts. This is the exclusive remedy for consequential damages.

**E. WHAT YOU MUST DO**

1. Return the warranty card.
2. Obtain from us, while this warranty is in effect, prior approval for return or repair of covered parts.
2. Return the wheelchair or part(s), freight pre-paid, to Sunrise Mobility Products Division at: 2842 Business Park Avenue, Fresno, CA 93727-1328.
3. Pay the cost of labor to repair or install parts.

**Sunrise Medical, Inc.**

7477 East Dry Creek Parkway • Longmont, Colorado • 80503 USA

(800) 333-4000

In Canada (800) 263-3390