

# GUARDIAN

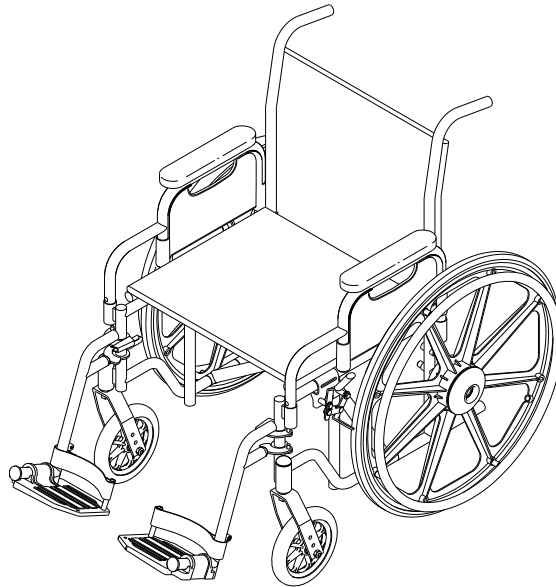

## *Guardian*<sup>®</sup> Easy Care Wheelchairs

### *User Instruction Manual & Warranty*

**1000 Series Transport, 2000 Series Standard, 2000HD Series Heavy Duty,  
3000 Series Lightweight, 4000 Series High Strength/Lightweight**

**DEALER:** THIS MANUAL MUST BE GIVEN TO THE USER OF THE WHEELCHAIR.

**USER:** BEFORE USING THIS WHEELCHAIR, READ THIS MANUAL AND SAVE FOR FUTURE REFERENCE.

## Fauteuils Roulants Easy Care *Guardian*<sup>®</sup>

### *Mode d'Emploi et Garantie*

**Transport de Série 1000, Standard 2000 Série, Lourds de Série 2000HD,  
Légers de Série 3000, Haute Résistance/Légers de Série 4000**

**REVENDEUR:** CE MANUEL DOIT ÊTRE REMIS À L'UTILISATEUR/UTILISATRICE DU FAUTEUIL ROULANT.

**UTILISATEUR/UTILISATRICE:** AVANT D'UTILISER CE FAUTEUIL ROULANT, LISEZ CE MANUEL ET CONSERVEZ-LE POUR RÉFÉRENCE ULTÉRIEURE.

## Sillas de Ruedas *Guardian*<sup>®</sup> de Easy Care

### *Manual de Instrucciones y Garantía para el Usuario*

**Transporte de Serie 1000, Estandar 2000 Serie, Uso Pesado de Série 2000HD,  
Ligera de Serie 3000, Alta Resistencia/Ligera de Serie 4000**

**DISTRIBUIDOR:** ESTE MANUAL DEBE SER ENTREGADO AL USUARIO DE LA SILLA DE RUEDAS.

**USUARIO:** ANTES DE USAR ESTA SILLA DE RUEDAS, LEA ESTE MANUAL Y GUÁRDELO PARA FUTURA REFERENCIA.





**SUNRISE LISTENS**

Thank you for choosing a Guardian wheelchair. We want to hear your questions or comments about this manual, the safety and reliability of your chair, and the service you receive from your supplier. Please feel free to write or call us at the address and telephone number below:

**Sunrise Medical**  
Customer Service Department  
7477 East Dry Creek Parkway  
Longmont, CO 80503  
(303) 218-4600 or (800) 333-4000

**FOR ANSWERS TO YOUR QUESTIONS**

Your authorized supplier knows your wheelchair best, and can answer most of your questions about chair safety, use and maintenance. For future reference, fill in the following:

Supplier: \_\_\_\_\_

Address: \_\_\_\_\_

Telephone: \_\_\_\_\_

Serial #: \_\_\_\_\_

Date/Purchased: \_\_\_\_\_

This manual contains important safety and maintenance instructions. Please read it carefully before using your wheelchair and refer to it as often as needed for safe and efficient use.

If you have questions regarding the safe use and/or assembly, maintenance or specifications of your wheelchair, contact Customer Service at 800-333-4000, 303-218-4600 or from Canada at 800-263-3390. Please have the Model and Serial Number of the product available.

For service and repair, remember your authorized Sunrise Medical dealer is able to provide the assistance you need.

Keep this manual in a safe place for future reference.

**SAVE THESE INSTRUCTIONS.**



<b>INTRODUCTION</b> .....	2
<b>TABLE OF CONTENTS</b> .....	3
<b>YOUR CHAIR AND ITS PARTS</b> .....	4
<b>GENERAL WARNINGS</b> .....	5
<b>WARNINGS: FALLS &amp; TIP-OVERS</b> .....	8
<b>WARNINGS: FOR SAFE USE</b> .....	12
<b>WARNINGS: COMPONENTS &amp; OPTIONS</b> .....	14
<b>CHAIR BASICS</b> .....	17
A. To Fold and Unfold Chair.....	17
<b>MAINTENANCE</b> .....	18
A. Maintenance Safety Precautions .....	18
B. Suggested Maintenance Procedures.....	18
<b>SAFETY INSPECTION CHECKLIST</b> .....	19
<b>SPECIFICATIONS</b> .....	20
<b>FRONT RIGGINGS</b> .....	21
A. Swing-Away Footrest Assembly Installation .....	21
B. Swing-Away Footrest Height Adjustment .....	21
C. Elevating Legrest Assembly Installation .....	21
D. Adjusting the Elevating Legrest Assembly.....	21
<b>ARMS</b> .....	22
A. Removing or Replacing Armrest .....	22
B. Removing Flip-Back Armrest .....	22
<b>SEAT AND BACK</b> .....	23
A. Fold Down Back – Transport Only .....	23
B. Replacing the Back Upholstery .....	23
C. Replacing the Seat Upholstery .....	23
<b>REAR WHEELS</b> .....	24
A. Removing/Installing the Rear Wheels.....	24
B. Replacing Rear Wheel Handrim.....	24
<b>FRONT CASTERS</b> .....	25
A. Installing/Replacing Front Casters and Forks.....	25
B. Adjusting Forks .....	25
C. Replacing/Repairing Front Caster Tire/Tube .....	25
<b>SEAT-TO-FLOOR HEIGHT</b> .....	26
A. Changing Seat-To-Floor Height.....	26
<b>ANTI-TIPPERS/WHEEL LOCKS</b> .....	27
A. Anti-Tippers.....	27
B. Wheel Lock Adjustment.....	27
<b>WARRANTY</b> .....	28
<b>FRANÇAIS</b> .....	30
<b>ESPAÑOL</b> .....	58

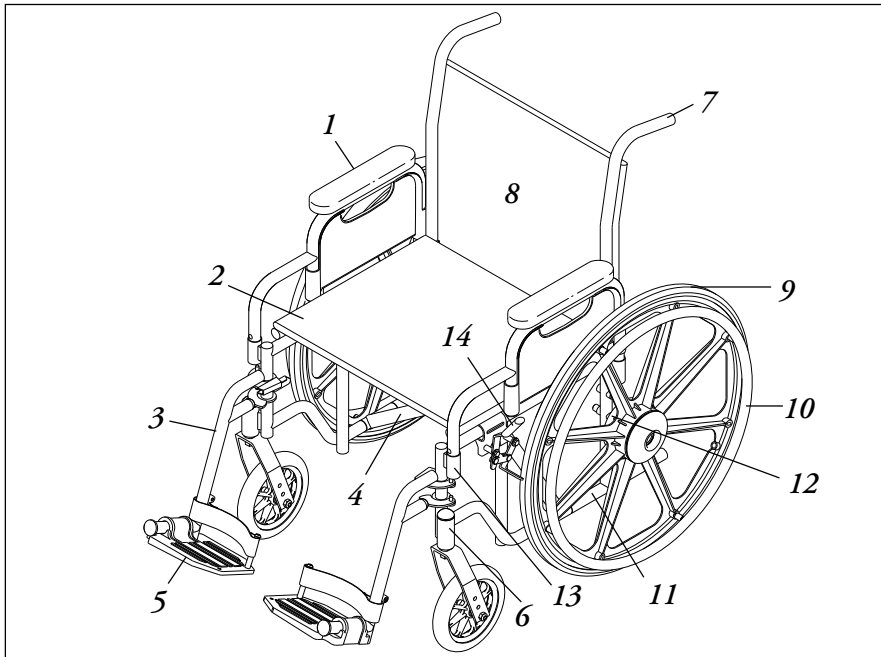

1. Armrest
2. Padded seat sling
3. Footrest
4. Crossbrace
5. Flip-up footplate
6. Bolt-on Front End - Caster housing, fork, and 8" wheel with over molded tire
7. Push handle
8. Padded backrest
9. 24" over molded tire with mag wheel (except 1000 Series Transport models)
10. Handrim (except 1000 Series Transport models)
11. Side frame
12. Threaded axle
13. Swing-away release latch (except Fixed Footrest models)
14. Wheel lock

## READ BEFORE USE

### A. CHOOSE THE RIGHT CHAIR & SAFETY OPTIONS

Sunrise provides a choice of many wheelchair styles to meet the needs of the wheelchair rider. However, final selection of the type of wheelchair, options and adjustments rests solely with you and your health care advisor. Choosing the best chair and set-up for your safety depends on such things as:

1. Your disability, strength, balance and coordination.
2. The types of hazards you must overcome in daily use (where you live and work, and other places you are likely to use your chair).
3. The need for options for your safety and comfort (such as anti-tip tubes, positioning belts, or special seating systems).

### B. REVIEW THIS MANUAL OFTEN

Before using this chair you, and each person who may assist you, should read this entire manual and make sure to follow all instructions. Review the warnings often, until they are second nature to you.

### C. WARNINGS

The word WARNING refers to a hazard or unsafe practice that may cause severe injury or death to you or to other persons. The Warnings are in four main sections, as follows:

#### 1. GENERAL WARNINGS

Here you will find a safety checklist and a summary of risks you need to be aware of before you ride this chair.

#### 2. WARNINGS - FALLS & TIP-OVERS

Here you will learn how to avoid a fall or tip-over while you perform daily activities in your chair.

#### 3. WARNINGS - FOR SAFE USE

Here you will learn about practices for the safe use of your chair.

#### 4. WARNINGS - COMPONENTS & OPTIONS

Here you will learn about the components of your chair and options you can select for safety. Consult your authorized supplier and your health care advisor to help you choose the best set-up and options for safe use.

**NOTE**— Where they apply, you will also find WARNINGS in other sections of this manual.

Heed all warnings in this section. If you fail to do so a fall, tip-over or loss of control may occur and cause severe injury to the rider or others.

## A. WEIGHT LIMIT

### WARNING

Do not exceed the weight limit listed on the product for combined weight of rider and items carried. If you do exceed the limit, damage to your chair, a fall, tip-over or loss of control may occur and cause severe injury to the rider or others.

## B. GETTING TO KNOW YOUR CHAIR

### WARNING

Every wheelchair is different. Take the time to learn the feel of this chair before you begin riding. Start slowly, with easy, smooth strokes. If you are used to a different chair, you may use too much force and tip over. If you use too much force, damage to your chair, a fall, tip-over or loss of control may occur and cause severe injury to the rider or others.

## C. TO REDUCE THE RISK OF AN ACCIDENT

### WARNING

1. BEFORE riding, you should be trained in the safe use of this chair by your health care advisor.
2. After engaging wheel locks, practice bending, reaching and transfers until you know the limit of your ability. Have someone help you until you know what can cause a fall or tip-over and how to avoid doing so.
3. Be aware that you must develop your own methods for safe use best suited to your level of function and ability.
4. NEVER try a new maneuver on your own until you are sure you can do it safely.
5. Get to know the areas where you plan to use your chair. Look for hazards and learn how to avoid them.
6. Use anti-tip tubes unless you are a skilled rider of this chair and are sure you are not at risk to tip over.

If you fail to heed these warnings damage to your chair, a fall, tip-over or loss of control may occur and cause severe injury to the rider or others.

## D. SAFETY CHECKLIST

### WARNING

#### Before Each Use of Your Chair:

1. Make sure the chair rolls easily and that all parts work smoothly. Check for noise, vibration, or a change in ease of use. (They may indicate loose fasteners, or damage to your chair.)
2. Repair any problem. Your authorized supplier can help you find and correct the problem.
3. If your chair has anti-tip tubes, lock them in place.

**NOTE**— See “Anti-Tip Tubes” for times you should not use them.

If you fail to heed these warnings damage to your chair, a fall, tip-over or loss of control may occur and cause severe injury to the rider or others.

## E. CHANGES & ADJUSTMENTS

### WARNING

1. If you modify or adjust this chair, it may increase the risk of a tip-over UNLESS you make other changes as well.
2. Always, consult your authorized supplier BEFORE you modify or adjust your chair.
3. We recommend that you use anti-tip tubes until you adapt to the change, and are sure you are not at risk to tip over.
4. Unauthorized modifications or use of parts not supplied or approved by Sunrise may change the chair structure. This will void the warranty and may cause a safety hazard.

If you fail to heed these warnings damage to your chair, a fall, tip-over or loss of control may occur and cause severe injury to the rider or others.

## F. ENVIRONMENTAL CONDITIONS

### WARNING

1. Use extra care if you must ride your chair on a wet or slick surface. If you are in doubt, ask for help.
2. Contact with water or excess moisture may cause your chair to rust or corrode. This could cause your chair to fail.
  - a. Do not use your chair in a shower, pool or other body of water. The chair tubing and parts are not watertight and may rust or corrode from the inside.
  - b. Avoid excess moisture (for example, do not leave your chair in a damp bathroom while taking a shower).
  - c. Dry your chair as soon as you can if it gets wet, or if you use water to clean it.

If you fail to heed these warnings damage to your chair, a fall, tip-over or loss of control may occur and cause severe injury to the rider or others.

## G. TERRAIN

### WARNING

1. Your chair is designed for use on firm, even surfaces such as concrete, asphalt and indoor floors and carpeting.
2. Do not operate your chair in sand, loose soil or over rough terrain. This may damage wheels or axles, or loosen fasteners of your chair.

If you fail to heed these warnings damage to your chair, a fall, tip-over or loss of control may occur and cause severe injury to the rider or others.

## H. STREET USE

### WARNING

**In most states, wheelchairs are not legal for use on public roads. Be alert to the danger of motor vehicles on roads or in parking lots.**

1. At night, or when lighting is poor, use reflective tape on your chair and clothing.
2. Due to your low position, it may be hard for drivers to see you. Make eye contact with drivers before you go forward. When in doubt, yield until you are sure it is safe.

If you fail to heed these warnings damage to your chair, a fall, tip-over or loss of control may occur and cause severe injury to the rider or others.

## I. MOTOR VEHICLE SAFETY

### WARNING

**Guardian wheelchairs do not meet federal standards for motor vehicle seating.**

1. NEVER let anyone sit in this chair while in a moving vehicle.
  - a. ALWAYS move the rider to an approved vehicle seat.
  - b. ALWAYS secure the rider with proper motor vehicle restraints.
  - c. In an accident or sudden stop the rider may be thrown from the chair. Wheelchair seat belts will not prevent this, and further injury may result from the belts or straps.
2. NEVER transport this chair in the front seat of a vehicle. It may shift and interfere with the driver.
3. ALWAYS secure this chair so that it cannot roll or shift.
4. Do not use any chair that has been involved in a motor vehicle accident.

If you fail to heed these warnings damage to your chair, a fall, tip-over or loss of control may occur and cause severe injury to the rider or others.

## J. WHEN YOU NEED HELP

### WARNING

#### **For The Rider:**

Make sure that each person who helps you reads and follows all warnings and instructions that apply.

#### **For Attendants:**

1. Work with the wheelchair user's doctor, nurse or therapist to learn safe methods best suited to your abilities and those of the wheelchair user.
2. Tell the wheelchair user what you plan to do, and explain what you expect the wheelchair user to do. This will put the wheelchair user at ease and reduce the risk of an accident.
3. Make sure the chair has push handles. They provide secure points for you to hold the rear of the chair to prevent a fall or tip-over. Check to make sure push handle grips will not rotate or slip off.
4. To prevent injury to your back, use good posture and proper body mechanics. When you lift or support the wheelchair user or tilt the chair, bend your knees slightly and keep your back as upright and straight as you can.
5. Remind the wheelchair user to lean back when you tilt the chair backward.
6. To avoid tripping, unlock and rotate anti-tip tubes up, out of the way. ALWAYS lock the rear wheels and lock anti-tip tubes in place if you must leave the wheelchair user alone, even for a moment. This will reduce the risk of a tip over or loss of control of the chair.
7. For instructions on descending a curb or single step please refer to Descending a Curb or Single Step section of this manual.

If you fail to heed these warnings damage to your chair, a fall, tip-over or loss of control may occur and cause severe injury to the wheelchair user or others.

## A. CENTER OF BALANCE

### WARNING

**The point where this chair will tip forward, back, or to the side depends on its center of balance and stability. How your chair is set up, the options you select and the changes you make may affect the risk of a fall or tip-over.**

1. Center of balance is affected by:
  - a. A change in the set-up of your chair, including:
    - Seating system consisting of cushion and or back support;
    - The seat height
  - b. A change in your body position, posture or weight distribution.
  - c. Riding your chair on a ramp or slope.
  - d. The use of a backpack or other options, and the amount of added weight.
2. To reduce the risk of an accident:
  - a. Consult your doctor, nurse or therapist to find out what axle and caster position is best for you.
  - b. Consult your authorized supplier BEFORE you modify or adjust this chair. Be aware that you may need to make other changes to correct the center of balance.
  - c. Have someone help you until you know the balance points of your chair and how to avoid a tip-over.
  - d. Use anti-tip tubes.

If you fail to heed these warnings damage to your chair, a fall, tip-over or loss of control may occur and cause severe injury to the wheelchair user or others.

## B. DRESSING OR CHANGING CLOTHES

### WARNING

**Your weight may shift if you dress or change clothes while seated in this chair.**

**To reduce the risk of a fall or tip-over:**

1. Rotate the front casters until they are as far forward as possible. This makes the chair more stable.
2. Lock anti-tip tubes in place. (If your chair does not have anti-tip tubes, back it up against a wall and lock both rear wheels).
3. Engage your wheel locks.

If you fail to heed these warnings damage to your chair, a fall, tip-over or loss of control may occur and cause severe injury to the wheelchair user or others.

## C. WHEELIES

### WARNING

**Doing a "wheelie" means balancing on the rear wheels of your chair while the front casters are in the air. It is dangerous to do a "wheelie" as a fall or tip-over may occur. However, if you do it safely, a "wheelie" can help you overcome curbs and obstacles.**

1. Consult your doctor, nurse or therapist to find out if you are a good candidate to learn to do a "wheelie."
2. Do not attempt a "wheelie" UNLESS you are a skilled wheelchair user of this chair or you have help.

If you fail to heed these warnings damage to your chair, a fall, tip-over or loss of control may occur and cause severe injury to the wheelchair user or others.

## D. OBSTACLES

### WARNING

**Obstacles and road hazards (such as potholes and broken pavement) can damage your chair and may cause a fall, tip-over or loss of control.**

#### To avoid these risks:

1. Keep a lookout for danger – scan the area well ahead of your chair as you ride.
2. Make sure the floor areas where you live and work are level and free of obstacles.
3. Remove or cover threshold strips between rooms.
4. Install a ramp at entry or exit doors. Make sure there is not a drop off at the bottom of the ramp.
5. To Help Correct Your Center of Balance:
  - a. Lean your upper body FORWARD slightly as you go UP over an obstacle.
  - b. Press your upper body BACKWARD as you go DOWN from a higher to a lower level.
6. If your chair has anti-tip tubes, lock them in place before you go UP over an obstacle.
7. Keep both of your hands on the handrims as you go over an obstacle.
8. Never push or pull on an object (such as furniture or a doorjamb) to propel your chair.

If you fail to heed these warnings damage to your chair, a fall, tip-over or loss of control may occur and cause severe injury to the wheelchair user or others.

## E. REACHING OR LEANING

### WARNING

**If you reach or lean it will affect the center of balance of your chair. This may cause you to fall or tip over. When in doubt, ask for help or use a device to extend your reach.**

1. NEVER reach or lean if you must shift your weight sideways or rise up off the seat.
2. NEVER reach or lean if you must move forward in your seat to do so. Always keep your buttocks in contact with the backrest.
3. NEVER reach with both hands (you may not be able to catch yourself to prevent a fall if the chair tips).
4. NEVER reach or lean to the rear unless your chair has anti-tip tubes locked in place.
5. DO NOT reach or lean over the top of the seat back. This may damage one or both backrest tubes and cause you to fall.
6. If You Must Reach Or Lean:
  - a. Do not lock the rear wheels. This creates a tip point and makes a fall or tip-over more likely.
  - b. Do not put pressure on the footrests.

**NOTE**– Leaning forward puts pressure on the footrests and may cause the chair to tip if you lean too far.

- c. Move your chair as close as you can to the object you wish to reach.
- d. Do not try to pick up an object from the floor by reaching down between your knees. You are less likely to tip if you reach to the side of your chair.
- e. Rotate the front casters until they are as far forward as possible. This makes the chair more stable.

**NOTE**– To do this: Move your chair past the object you want to reach, then back up alongside it. Backing up will rotate the casters forward.

- f. Firmly grasp a rear wheel or an armrest with one hand. This will help to prevent a fall if the chair tips.

If you fail to heed these warnings damage to your chair, a fall, tip-over or loss of control may occur and cause severe injury to the wheelchair user or others.

## F. MOVING BACKWARD

### WARNING

**Use extra care when you move your chair backward. Your chair is most stable when you propel yourself forward. You may lose control or tip over if one of the rear wheels hits an object and stops rolling.**

1. Propel your chair slowly and smoothly.
2. If your chair has anti-tip tubes, make sure to lock them in place.
3. Stop often and check to be sure your path is clear.

If you fail to heed these warnings damage to your chair, a fall, tip-over or loss of control may occur and cause severe injury to the wheelchair user or others.

## G. RAMPS, SLOPES & SIDE HILLS

### WARNING

**Riding on a slope, which includes a ramp or side hill, will change the center of balance of your chair. Your chair is less stable when it is at an angle. Anti-tip tubes may not prevent a fall or tip-over.**

1. Do not use your chair on a slope steeper than 10%. (A 10% slope means: one foot in elevation for every ten feet of slope length.)
2. Always go as straight up and as straight down as you can. (Do not “cut the corner” on a slope or ramp.)
3. Do not turn or change direction on a slope.
4. Always stay in the CENTER of the ramp. Make sure ramp is wide enough that you are not at risk that a wheel may fall over the edge.
5. Do not stop on a steep slope. If you stop, you may lose control of your chair.
6. NEVER use rear wheel locks to try to slow or stop your chair. This is likely to cause your chair to veer out of control.
7. Beware of:
  - a. Wet or slippery surfaces.
  - b. A change in grade on a slope (or a lip, bump or depression). These may cause a fall or tip-over.
  - c. A drop-off at the bottom of a slope. A drop-off of as small as 3/4 inch can stop a front caster and cause the chair to tip forward.
8. To Reduce the Risk of a Fall or Tip-Over:
  - a. Lean or press your body UPHILL. This will help adjust for the change in the center of balance caused by the slope or side hill.
  - b. Keep pressure on the handrims to control your speed on a down slope. If you go too fast you may lose control.
  - c. Ask for help any time you are in doubt.
9. Ramps At Home & Work - For your safety, ramps at home and work must meet all legal requirements for your area. We recommend:
  - a. Width. At least four feet wide.
  - b. Guardrails. To reduce the risk of a fall, sides of ramp must have guardrails (or raised borders at least three inches high).
  - c. Slope. Not more than a 10% grade.
  - d. Surface. Flat and even, with a thin carpet or other non-skid material. (Make sure there is no lip, bump or depression.)
  - e. Bracing. Ramp must be STURDY. You may need bracing so ramp does not “bow” when you ride on it.
  - f. Avoid A Drop Off. You may need a section at the top or bottom to smooth out the transition.

If you fail to heed these warnings damage to your chair, a fall, tip-over or loss of control may occur and cause severe injury to the wheelchair user or others.

## H. TRANSFER

### WARNING

**It is dangerous to transfer on your own. It requires good balance and agility. Be aware that there is a point during every transfer when the wheelchair seat is not below you. To avoid a fall:**

1. Work with your health care advisor to learn safe methods.
  - a. Learn how to position your body and how to support yourself during a transfer.
  - b. Have someone help you until you know how to do a safe transfer on your own.
2. Lock the rear wheels before you transfer. This keeps the rear wheels from rolling.

**NOTE**– This will NOT keep your chair from sliding away from you or tipping.

3. Move your chair as close as you can to the seat you are transferring to. If possible, use a transfer board.
4. Rotate the front casters until they are as far forward as possible.
5. If you can, remove or swing footrests out of the way.
  - a. Make sure your feet do not catch in the space between the footrests.
  - b. Avoid putting weight on the footrests as this may cause the chair to tip.
6. Make sure armrests are out of the way and do not interfere.
7. Transfer as far back onto the seat surface as you can. This will reduce the risk that the chair will tip or move away from you.

If you fail to heed these warnings damage to your chair, a fall, tip-over or loss of control may occur and cause severe injury to the wheelchair user or others.

## I. CURBS & STEPS

### WARNING

1. Each person who helps you should read and follow the warnings “For Safe Use” section
2. Do not try to climb or descend a curb or step alone UNLESS you are a skilled wheelchair user of this chair and:
  - a. You can safely do a “wheelie”; and
  - b. You are sure you have the strength and balance to do so.
3. Unlock and rotate anti-tip tubes up, out of the way, so they do not interfere.
4. Do not try to climb a high curb or step (more than 4 inches high) UNLESS you have help. Doing so may cause your chair to exceed its balance point and tip over.
5. Go straight up and straight down a curb or step. If you climb or descend at an angle, a fall or tip-over is likely.
6. Be aware that the impact of dropping down from a curb or step can damage your chair or loosen fasteners.

If you fail to heed these warnings damage to your chair, a fall, tip-over or loss of control may occur and cause severe injury to the wheelchair user or others.

## J. STAIRS

1. NEVER use this chair on stairs UNLESS you have someone to help you. Doing so is likely to cause a fall or tip-over.
2. Persons who help you should read and follow the warnings “For Attendants” and “For Safe Use”.

If you fail to heed these warnings damage to your chair, a fall, tip-over or loss of control may occur and cause severe injury to the wheelchair user or others.

## K. ESCALATORS

NEVER use this chair on an escalator, even with an attendant. If you do, a fall or tip-over is likely.

If you fail to heed these warnings damage to your chair, a fall, tip-over or loss of control may occur and cause severe injury to the wheelchair user or others.

**⚠ WARNING**

Before you assist a wheelchair user, be sure to read the warnings “For Attendants” and follow all instructions that apply. Be aware that you will need to learn safe methods best suited to your abilities.

**A. DESCENDING A CURB OR SINGLE STEP****⚠ WARNING**

Follow these steps to help a wheelchair user descend a curb or single step going **BACKWARD**:

1. Stay at the rear of the chair.
2. Several feet before you reach the edge of the curb or step, turn the chair around and pull it backward.
3. While looking over your shoulder, carefully step back until you are off the curb or stair and standing on the lower level.
4. Pull the chair toward you until the rear wheels reach the edge of the curb or step. Then allow the rear wheels to slowly roll down onto the lower level.
5. When the rear wheels are safely on the lower level, tilt the chair back to its balance point. This will lift the front casters off the curb or step.
6. Keep the chair in balance and take small steps backward. Turn the chair around and gently lower front casters to the ground.

If you fail to heed these warnings damage to your chair, a fall, tip-over or loss of control may occur and cause severe injury to the wheelchair user or others.

**B. CLIMBING A CURB OR SINGLE STEP****⚠ WARNING**

Follow these steps to help the wheelchair user climb a curb or single step going **FORWARD**:

1. Stay behind the chair.
2. Face the curb and tilt the chair up on the rear wheels so that the front casters clear the curb or step.
3. Move forward, placing the front casters on the upper level as soon as you are sure they are past the edge.
4. Continue forward until the rear wheels contact the face of the curb or step. Lift and roll the rear wheels to the upper level.

If you fail to heed these warnings damage to your chair, a fall, tip-over or loss of control may occur and cause severe injury to the wheelchair user or others.

**C. CLIMBING STAIRS****⚠ WARNING**

1. Use at least two attendants to move a chair and wheelchair user up stairs.
2. Move the chair and wheelchair user **BACKWARD** up the stairs.
3. The person at the rear is in control. He or she tilts the chair back to its balance point.
4. A second attendant at the front firmly grasps a non-detachable part of the front frame and lifts the chair up and over one stair at a time.
5. The attendants move to the next stair up. Repeat for each stair, until you reach the landing.

If you fail to heed these warnings damage to your chair, a fall, tip-over or loss of control may occur and cause severe injury to the wheelchair user or others.

## D. DESCENDING STAIRS

### **WARNING**

1. Use at least two attendants to move a chair and wheelchair user down stairs.
2. Move the chair and wheelchair user FORWARD down the stairs.
3. The person at the rear is in control. He or she tilts the chair to the balance point of the rear wheels and rolls it to the edge of the top step.
4. A second attendant stands on the third step from the top and grasps the chair frame. He or she lowers the chair one step at a time by letting the rear wheels roll over the stair edge.
5. The attendants move to the next stair down. Repeat for each stair, until you reach the landing.

If you fail to heed these warnings damage to your chair, a fall, tip-over or loss of control may occur and cause severe injury to the wheelchair user or others.

## E. MAINTENANCE

### **WARNING**

1. Inspect and maintain this chair strictly per chart.
2. If you detect a problem, make sure to service or repair the chair before use.
3. At least once a year, have a complete inspection, safety check and service of your chair made by an authorized supplier.

If you fail to heed these warnings damage to your chair, a fall, tip-over or loss of control may occur and cause severe injury to the wheelchair user or others. For additional maintenance information see Maintenance section.

## A. ANTI-TIP TUBES (OPTIONAL)

### **WARNING**

**Anti-tip tubes can help keep your chair from tipping over backward in most normal conditions.**

1. Sunrise recommends use Of anti-tip tubes:
  - a. UNLESS you are a skilled wheelchair user of this chair and are sure you are not at risk to tip over.
  - b. Each time you modify or adjust your chair. The change may make it easier to tip backward. Use anti-tip tubes until you adapt to the change, and are sure you are not at risk to tip over.
2. When locked in place (in the “correct” position) anti-tip tubes should be BETWEEN 1 1/2 to 2 inches off the ground.
  - a. If set too HIGH, they may not prevent a tip-over.
  - b. If set too LOW, they may “hang up” on obstacles you can expect in normal use. If this occurs, you may fall or your chair may tip over.
3. Keep anti-tip tubes locked in place UNLESS:
  - a. You have an attendant; or
  - b. You have to climb or descend a curb, or overcome an obstacle, and can safely do so without them. At these times, make sure anti-tip tubes are up, out of the way.

If you fail to heed these warnings damage to your chair, a fall, tip-over or loss of control may occur and cause severe injury to the wheelchair user or others.

## B. ARMRESTS

### **WARNING**

1. NEVER lift this chair by its armrests. They may come loose or break.
2. Lift this chair only by non-detachable parts of the main frame.

If you fail to heed these warnings damage to your chair, a fall, tip-over or loss of control may occur and cause severe injury to the wheelchair user or others.

## C. CUSHIONS & SLING SEATS

### WARNING

1. Sling seats and standard foam cushions are not designed for the relief of pressure.
2. If you suffer from pressure sores, or if you are at risk that they will occur, you may need a special seating system or a device to control your posture. Consult your doctor, nurse or therapist to find out if you need such a device for your well-being.

If you fail to heed these warnings damage to your chair, a fall, tip-over or loss of control may occur and cause severe injury to the wheelchair user or others.

## D. FASTENERS

### WARNING

**Many of the screws, bolts and nuts on this chair are special high-strength fasteners. Use of improper fasteners may cause your chair to fail.**

1. ONLY use fasteners provided by an authorized supplier.
2. Over- or under-tightened fasteners may fail or cause damage to chair parts.
3. If bolts or screws become loose, tighten them as soon as you can.

If you fail to heed these warnings damage to your chair, a fall, tip-over or loss of control may occur and cause severe injury to the wheelchair user or others.

## E. FOOTRESTS

### WARNING

1. At the lowest point, footrests should be AT LEAST 2 1/2 INCHES off the ground. If set too LOW, they may "hang up" on obstacles you can expect to find in normal use. This may cause the chair to stop suddenly and tip forward.
2. To Avoid A Trip or Fall When You Transfer:
  - a. Make sure your feet do not "hang up" or get caught in the space between the footrests.
  - b. Avoid putting weight on the footrests, as the chair may tip forward.
3. NEVER lift this chair by the footrests. Footrests detach and will not bear the weight of this chair. Lift this chair only by non-detachable parts of the main frame.

If you fail to heed these warnings damage to your chair, a fall, tip-over or loss of control may occur and cause severe injury to the wheelchair user or others.

## F. POWER DRIVE

### WARNING

**Do not install a power drive on any Guardian Easy Care wheelchair. If you do:**

1. It will affect the center of balance of your chair and may cause a fall or tip-over.
2. It will alter the frame and void the warranty.

If you fail to heed these warnings damage to your chair, a fall, tip-over or loss of control may occur and cause severe injury to the wheelchair user or others.

## G. PUSH HANDLES

### WARNING

**When you have an attendant, make sure that this chair has push handles.**

1. Push handles provide secure points for an attendant to hold the rear of this chair, to prevent a fall or tip-over. Make sure to use push handles when you have an attendant.
2. Check to make sure push handle grips will not rotate or slip off.

If you fail to heed these warnings damage to your chair, a fall, tip-over or loss of control may occur and cause severe injury to the wheelchair user or others.

## H. REAR WHEELS

### WARNING

**A change in set-up of the rear wheels will affect the center of balance of your chair.**

1. The farther you move the rear axles FORWARD, the more likely it is that your chair will tip over backward.
2. Consult your doctor, nurse or therapist to find the best rear axle set-up for your chair. Do not change the set-up UNLESS you are sure you are not at risk to tip over.
3. Adjust the rear wheel locks after you make any change to the rear axles.
  - a. If you fail to do so, the wheel locks may not work.
  - b. Make sure the wheel lock arm embeds in each tire at least 1/8 inch when locked.

If you fail to heed these warnings damage to your chair, a fall, tip-over or loss of control may occur and cause severe injury to the wheelchair user or others.

## I. REAR WHEEL LOCKS

### WARNING

**Rear wheel locks are NOT designed to slow or stop a moving wheelchair. Use them only to keep the rear wheels from rolling when your chair is at a complete stop.**

1. NEVER use rear wheel locks to try to slow or stop your chair when it is moving. Doing so may cause you to veer out of control.
2. To keep the rear wheels from rolling, always set both rear wheel locks when you transfer to or from your chair.
3. Make sure wheel lock arms embed in tires at least 1/8 inch when locked. If you fail to do so, the locks may not work.

If you fail to heed these warnings damage to your chair, a fall, tip-over or loss of control may occur and cause severe injury to the wheelchair user or others.

## J. MODIFIED SEATING SYSTEMS

### WARNING

**Use of a seating system not approved by Sunrise may alter the center of balance of this chair. This may cause the chair to tip over.**

1. Do not change the seating system of your chair UNLESS you consult your authorized supplier first.
2. Use of a seating system not approved by Sunrise may affect the folding mechanism of this chair.

If you fail to heed these warnings damage to your chair, a fall, tip-over or loss of control may occur and cause severe injury to the wheelchair user or others.

## K. UPHOLSTERY FABRIC

### WARNING

1. Replace worn or torn fabric of seat and seat back as soon as you can. If you fail to do so, the seat may fail.
2. Sling fabric will weaken with age and use. Look for fraying or thin spots, or stretching of fabrics at rivet holes.
3. "Dropping down" into your chair will weaken fabric and result in the need to inspect and replace the seat more often.
4. Be aware that laundering or excess moisture will reduce flame retardation of the fabric.

If you fail to heed these warnings damage to your chair, a fall, tip-over or loss of control may occur and cause severe injury to the wheelchair user or others.

## A. TO FOLD & UNFOLD CHAIR

### **⚠ WARNING**

**NEVER let your fingers come between the seat rail and the frame rail when you open or fold this chair. This may cause a pinch or crush-type injury.**

#### **1. To Fold Chair:**

- a. Remove back insert (if any).
- b. Make sure footrests are out of the way before you fold chair. (Swing away, flip up or remove footrests.)
- c. Remove cushion (if any).
- d. Stand to one side of chair.
- e. With both hands grasp center of seat sling and lift sharply until chair folds.

#### **2. To Unfold Chair:**

- a. Stand to one side of chair.
- b. From side, tilt chair toward you far enough to take the weight off the opposite wheel.
- c. Push down on the seat rail closest to you until chair opens fully.
- d. Make sure seat rail tubes drop into frame saddles.

## A. MAINTENANCE SAFETY PRECAUTIONS

### **⚠ WARNING**

After ANY adjustments, repair or service and BEFORE use, make sure all attaching hardware is tightened securely – otherwise injury or damage may result.

**CAUTION**– DO NOT over tighten hardware attaching to the frame. This could cause damage to the frame tubing.

## B. SUGGESTED MAINTENANCE PROCEDURES

1. Before using your wheelchair, make sure all nuts and bolts are tight. Check all parts for damage or wear and replace. Check all parts for proper adjustment.

### **⚠ WARNING**

**DO NOT use the wheelchair unless it has the proper tire pressure (p.s.i.). DO NOT over-inflate the tires. Failure to follow these suggestions may cause the tire to explode and cause bodily harm.**

2. If tires are pneumatic, recommend tire pressure is listed on the sidewall of the tire.
3. The wheels and tires should be checked periodically for cracks and wear, and should be replaced when necessary by your authorized dealer or by a qualified technician.
4. Periodically check hand rims to ensure they are securely attached to the rear wheels. Refer to REPLACING REAR WHEEL HANDRIM in the “REAR WHEELS” section of this manual.
5. Periodically adjust wheel locks in correlation to the tire wear. Refer to WHEEL LOCK ADJUSTMENT in the “ANTI-TIPPERS/WHEEL LOCKS” section of this manual.
6. Periodically check front caster and rear wheel hubs to make sure they are clean.
7. Check upholstery for sagging, rips or tears.

**NOTE**– Every six months take your wheelchair to a qualified dealer for a thorough inspection and servicing. Regular cleaning will reveal loose or worn parts and enhance the smooth operation of your wheelchair. To operate properly and safely, your wheelchair must be cared for just like any other vehicle. Routine maintenance will extend the life and efficiency of your wheelchair.

Initial adjustments should be made to suit personal body structure/preference. Thereafter follow these maintenance procedures:

Initially	Weekly	Monthly	Periodically	INSPECT...
✓	✓		✓	<b>GENERAL</b> <ul style="list-style-type: none"> <li>• Wheelchair rolls straight (no excessive drag or pull to one side).</li> </ul>
✓			✓	<b>SEAT AND BACK</b> <ul style="list-style-type: none"> <li>• Inspect for rips or sagging.</li> <li>• Inspect for loose or broken hardware.</li> </ul>
✓				<b>REAR WHEELS</b> <ul style="list-style-type: none"> <li>• No excessive side movement or binding when lifted and spun.</li> </ul>
✓			✓	<b>HANDRIMS</b> <ul style="list-style-type: none"> <li>• Inspect for signs of rough edges or peeling.</li> </ul>
✓	✓			<b>SPOKES</b> <ul style="list-style-type: none"> <li>• Inspect for broken spokes.</li> </ul>
✓	✓			<b>FRONT CASTER</b> <ul style="list-style-type: none"> <li>• Inspect wheel/fork assembly for proper tension by spinning caster. Caster should come to a gradual stop.</li> <li>• Loosen/tighten locknut if wheel wobbles noticeably or binds to a stop.</li> <li>• Wheel bearings are clean and free of moisture.</li> </ul>
			✓	<b>CAUTION: As with any vehicle, the wheels and tires should be checked periodically for cracks and wear and should be replaced.</b>
✓	✓		✓	<b>TIRES</b> <ul style="list-style-type: none"> <li>• Inspect for flat spots and wear.</li> <li>• If pneumatic tires, check for proper inflations.</li> </ul>
✓	✓		✓	<b>CAUTION: As with any vehicle, the wheels and tires should be checked periodically for cracks and wear and should be replaced.</b>
✓		✓		<b>WHEEL LOCKS</b> <ul style="list-style-type: none"> <li>• Do not interfere with tires when rolling.</li> <li>• Pivot points free of wear and looseness.</li> <li>• Wheel locks easy to engage.</li> </ul>
✓			✓	<b>CLEANING</b> <ul style="list-style-type: none"> <li>• Clean upholstery and armrests.</li> </ul>

17, 19 in.	16 & 18 in.	20, 22 & 24 in.	26, 28 & 30 in.	16, 18 & 20 in.	16, 18 & 20 in.
16 inches	16 inches	18 inches 16 inches*	20 inches	16 inches	16 inches
21 1/2, 23 1/2 in. N/A	22 1/2, 24 1/2 in. 24 1/2, 26 1/2 in.	N/A 29 1/2, 30 1/2, 32 1/2 in.	N/A 35, 37, 39 in.	N/A 23, 25, 27 in.	N/A 23, 25, 27 in.
24 inches	Fixed Arm: 32 in. Removable Arm 29 in.	32 inches	37 inches	30 1/2 in.	30 1/2 in.
19 inches N/A	19 3/4 in. 17 3/4 in.	19 3/4 in. 17 3/4 in.*	19 3/4 in. N/A	19 3/4 in. 17 3/4 in.	19 3/4 in. 17 3/4 in.
Fixed & Fold Down	Fixed	Fixed	Fixed	Fixed	Adjustable
17 inches	16 inches	16 inches	18 in.	16 inches	16 - 18 in.
Fixed Full Length	Fixed or Removable Full or Desk Length	Removable Full Length Removable Desk Length	Removable Desk Length	Removable Desk Length	Flip Back Removable Desk Length
Swing-Away Footrest	Fixed Footrest Swing-Away Footrest Elevating Legrest	Swing-Away Footrest Elevating Legrest	Swing-Away Footrest Elevating Legrest	Swing-Away Footrest Elevating Legrest	Swing-Away Footrest Elevating Legrest
Single Position	Dual Position	Single Position Dual Position*	Single Position	Dual Position	Dual Position
8x1 in. Rubber	Composite Mag Style	Composite Mag Style	Steel Mag Style	Composite Mag Style	Composite Mag Style
N/A	Composite	Chromed Steel	Chromed Steel	Composite	Aluminum
Push-to-Lock	Push-to-Lock	Push-to-Lock	Pull-to-Lock	Push-to-Lock	Pull-to-Lock
8x1 in. Rubber	8x1 in. Rubber	8x2 in. Rubber	8x2 in. Rubber	8x1 in. Rubber	8x1 in. Rubber
Nylon	Vinyl	Vinyl	Nylon	Nylon	Nylon

\*20 inch only

### **⚠ WARNING**

After ANY adjustments, repair or service and BEFORE use, make sure all attaching hardware is tightened securely – otherwise injury or damage may result.

#### **A. SWING-AWAY FOOTREST ASSEMBLY INSTALLATION (FIGURE 1)**

1. Turn the footrest to the side (open footplate is perpendicular to wheelchair).
2. Install the hinge plates (A) on the footrest onto the hinge pins (B) on the wheelchair frame.
3. Push the footrest towards the inside of the wheelchair until it locks into place.

**NOTE**– The footplate will be on the inside of the wheelchair when locked in place.

4. Repeat this procedure for the other footrest assembly.
5. To release the footrest, push the footrest release lever (C) inward, rotate footrest outward.

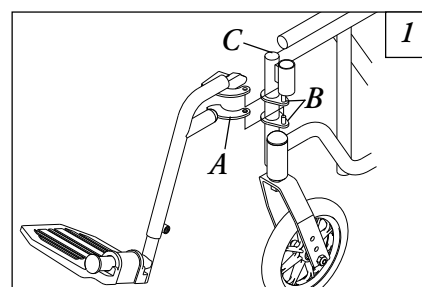

#### **B. SWING-AWAY FOOTREST HEIGHT ADJUSTMENT (FIGURE 2)**

**NOTE**– Release the footrest locking mechanism and lift the footrest off of the hinge pins. Lay the assembly on a flat surface to simplify this procedure.

1. Remove impact guards and/or calf strap, if necessary.
2. Loosen, but do not remove the bolt and locknut (D) that secure the lower footrest assembly (E) to the upper footrest support (F).
3. Reposition the lower footrest assembly to the desired height.
4. Securely tighten the bolt and locknut.
5. Repeat this procedure for the other footrest, if necessary.
6. Replace impact guards and/or calf strap, if necessary.

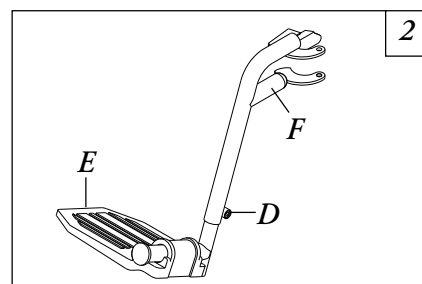

#### **C. ELEVATING LEGREST ASSEMBLY INSTALLATION (FIGURE 3)**

1. Place legrest assembly on the outside of the wheelchair and install the hinge plates (A) onto the hinge pins (B) on wheelchair frame.
2. Rotate legrest assembly toward the inside of the wheelchair until it locks in place.
3. Repeat this procedure for other legrest assembly.
4. After seated in wheelchair, adjust footrest to correct height by loosening the locknut (D) and sliding the lower footrest assembly (F) tube up or down until desired height is achieved.
5. Tighten locknut securely.
6. To release the legrest, push the legrest release handle (G) toward the inside of the wheelchair (facing the front of the wheelchair) and swing the legrest assembly to the outside of the wheelchair.

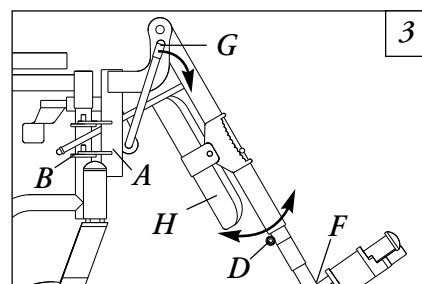

#### **D . ADJUSTING THE ELEVATING LEGREST ASSEMBLY (FIGURES 3, 4 & 5)**

**NOTE**– Adjustments to Fixed Front End Legrests are performed in the same fashion as the elevating legrest.

1. To adjust the elevating legrest, raise legs until the desired height is obtained.
2. To reposition legrest to normal position, support leg with one hand and push release lever (G) downward with other hand.
3. To adjust the calf pad (H), turn pad towards the outside of the wheelchair (Fig. 4).
4. Slide the calf pad up or down until the desired position is obtained (Fig. 4).
5. To secure the calf pad, turn the calf pad towards the inside of the wheelchair (Fig. 5).

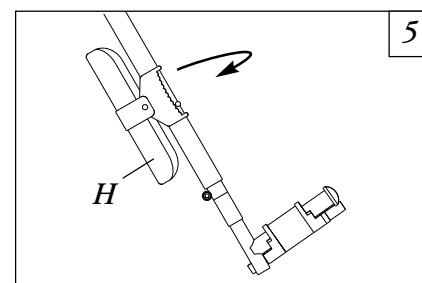
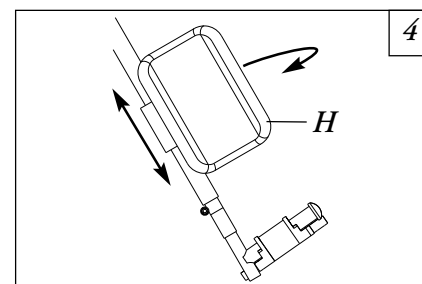

**⚠ WARNING**

After ANY adjustments, repair or service and BEFORE use, make sure all attaching hardware is tightened securely – otherwise injury or damage may result.

**A. REMOVING OR REPLACING ARMREST (FIGURE 1)**  
 (Removable armrests only)
**⚠ WARNING**

Make sure the armrest is securely locked BEFORE using the wheelchair.

1. Press the armrest release button (A) located on the armrest.
2. Remove the armrest from the arm sockets (B) by pulling straight up.
3. Replace the armrest by reversing STEPS 1-2.

**Guardian Plus Models**

**NOTE:** Armrest may be reversed to allow greater access for propelling.

**B. REMOVING FLIP-BACK ARMREST**  
 (4000 Series armrests only)
**⚠ WARNING**

Make sure the armrest is securely locked BEFORE using the wheelchair.

1. Press the armrest release lever located on the armrest.
2. Flip the armrest back.
3. Unscrew bolt at back of armrest and pull armrest up to remove.
4. Replace the armrest by reversing STEPS 1-3.

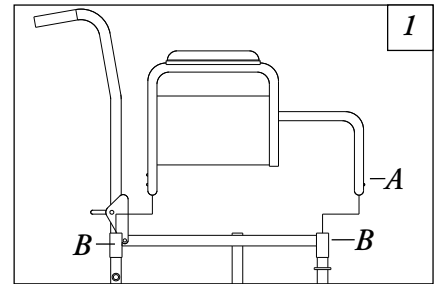

### **⚠ WARNING**

After ANY adjustments, repair or service and BEFORE use, make sure all attaching hardware is tightened securely; otherwise injury or damage may result.

#### **A. FOLD DOWN BACK – TRANSPORT ONLY (FIGURE 1)**

##### **Folding:**

1. Lift up the two release levers (A) on the back canes (B).
2. Pull back on the handles (C) to the desired position

##### **Unfolding:**

1. Pull on the two back canes until the release levers lock in place.

**NOTE**– There will be an audible click.

2. Pull on the handles to make sure the back is locked in place.

### **⚠ WARNING**

Make sure the release levers are securely locked in place BEFORE using the wheelchair.

#### **B. REPLACING THE BACK UPHOLSTERY (FIGURE 2)**

1. Remove the screws and washers that secure the existing back upholstery to the back canes.
2. Position new back upholstery (D) on back canes as shown in FIGURE 2.
3. Securely tighten the new back upholstery to the back canes with the screws (E) and washers (F).

#### **C. REPLACING THE SEAT UPHOLSTERY (FIGURE 3)**

1. Remove the eight screws (G) that secure the existing seat upholstery (H) to the cross braces.
2. Remove the existing seat upholstery from the cross braces.
3. Install the new seat upholstery by reversing STEPS 1-2.

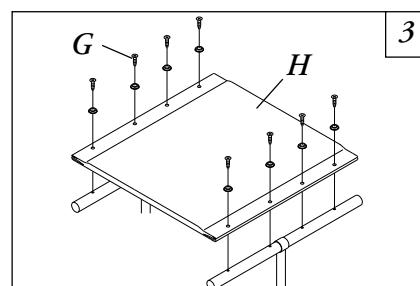
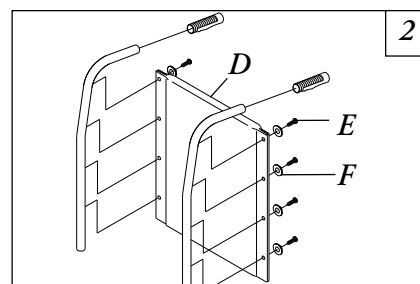
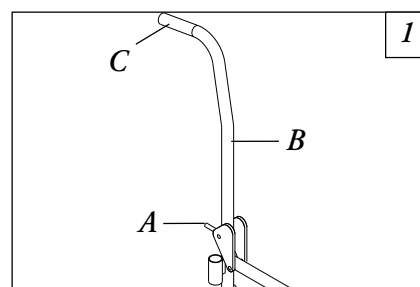

### **⚠ WARNING**

After ANY adjustments, repair or service and BEFORE use, make sure all attaching hardware is tightened securely – otherwise injury or damage may result.

#### **A. REMOVING/INSTALLING THE REAR WHEELS (FIGURE 1)**

1. Remove the dust cap (A) (if equipped), hex screw (B) and locknut (C) that secure the rear wheel (D) and axle spacer (E) to the wheelchair.
2. Repeat STEP 1 for the opposite rear wheel.
3. To reinstall the rear wheel onto the wheelchair, reverse STEPS 1-2.

**NOTE**– Make sure axle spacer is between rear wheel and wheelchair frame.

#### **B. REPLACING REAR WHEEL HANDRIM (FIGURE 2)**

1. Remove the rear wheel from the wheelchair
2. Remove the nuts (F) and washers that secure the handrim (G) to the rear wheel.
3. Remove the existing hand rim.
4. Install the new hand rim by reversing STEPS 1-3.
5. Repeat the procedure for the opposite rear wheel if necessary.

### **⚠ WARNING**

Replacement of rear wheel tire or tube **MUST** be performed by a qualified technician.

**CAUTION**– As with any vehicle, the wheels and tires should be checked periodically for cracks and wear, and should be replaced.

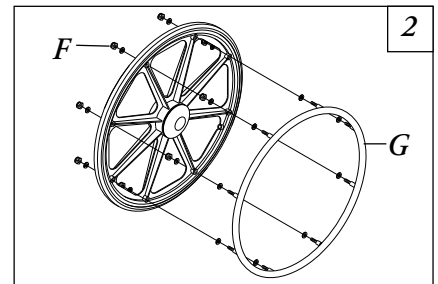
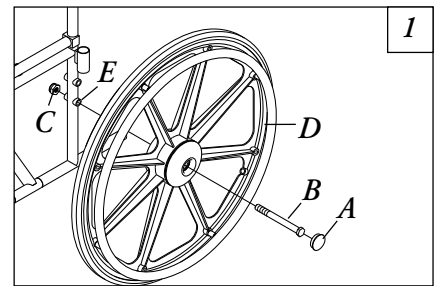

### **⚠ WARNING**

After ANY adjustments, repair or service and BEFORE use, make sure all attaching hardware is tightened securely – otherwise injury or damage may result.

#### **A. INSTALLING/REPLACING FRONT CASTERS AND FORKS (FIGURE 1)**

1. Remove the caster (A) from the fork (B). Refer to REPLACING FRONT CASTERS in this section of the manual.
2. Remove the dust cover (C).
3. Remove the locknut (D) and nylon washer (E) that secure the fork to the caster head tube (F).
4. Drop the fork out of the caster head tube.
5. Slide the new fork into the caster head tube and reassemble by reversing STEPS 1-4.
6. Adjust the forks. Refer to ADJUSTING FORKS in this section of the manual.
7. Repeat STEPS 1-6 for opposite fork, if necessary.

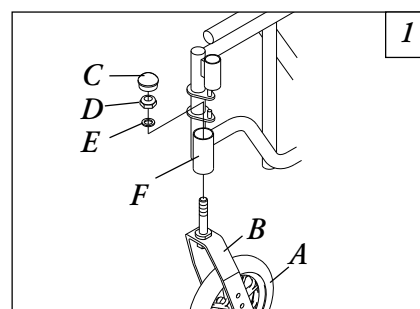

#### **B. ADJUSTING FORKS (FIGURE 1)**

1. Remove the dust cover (C).
2. To properly tighten caster journal system and guard against flutter, perform the following check:
  - a. Tip back the wheelchair to floor.
  - b. Pivot both forks and casters to top of their arc simultaneously.
  - c. Let casters drop to bottom of arc (wheels should swing once to one-side, then immediately rest in a straight downward position).
  - d. Adjust locknuts (D) according to freedom of caster swing.
3. Test wheelchair for maneuverability.
4. Readjust locknuts if necessary, and repeat STEPS 2-3 until correct.
5. Snap dust cover over the locknut and stem.

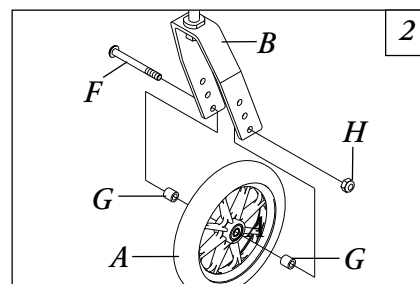

#### **C. REPLACING/REPAIRING FRONT CASTER TIRE/TUBE (FIGURE 2)**

### **⚠ WARNING**

Replacement of the front caster tire or tube **MUST** be performed by a qualified technician.

**CAUTION**– As with any vehicle, the wheels and tires should be checked periodically for cracks and wear, and should be replaced.

1. Remove the hex screw (F), washers (G) and locknut (H) that secure the front caster tire (A) to the fork (B).

**NOTE**– Washers are used on HEAVY DUTY/EXTRA WIDE wheelchairs only.

2. Install the new front caster tire onto the wheelchair by reversing STEP 1.
3. Repeat STEPS 1-2 for the opposite front caster tire if necessary.

**⚠ WARNING**

After ANY adjustments, repair or service and BEFORE use, make sure all attaching hardware is tightened securely – otherwise injury or damage may result.

**A. CHANGING SEAT-TO-FLOOR HEIGHT (FIGURES 1 & 2)**

**⚠ WARNING**

When changing the seat-to-floor height, the height of the anti-tippers must be adjusted as well.

**NOTE-** The Manufacturer recommends that the following procedure be performed by an authorized dealer or qualified technician.

1. Remove the rear wheels from the wheelchair. Refer to REMOVING/INSTALLING THE REAR WHEELS in the "REAR WHEELS" section of this manual.
2. Remove the front casters from the wheelchair. Refer to INSTALLING/REPLACING SIX OR EIGHT-INCH FRONT CASTERS AND FORKS in the "FRONT CASTERS" section of this manual.
3. Refer to the chart of front caster/fork and rear wheel sizes, to determine mounting positions for obtainable seat-to-floor heights.
4. Reinstall the front casters onto the wheelchair. Refer to Refer to INSTALLING/REPLACING SIX OR EIGHT-INCH FRONT CASTERS AND FORKS in the "FRONT CASTERS" section of this manual.
5. Reinstall the rear wheels onto the wheelchair. Refer to REMOVING/INSTALLING THE REAR WHEELS in the "REAR WHEELS" section of this manual.
6. Adjust Anti-tippers according to NEW seat-to-floor height. Refer to ANTI-TIPPERS in the "ANTI-TIPPERS/WHEEL LOCKS" section of this manual.

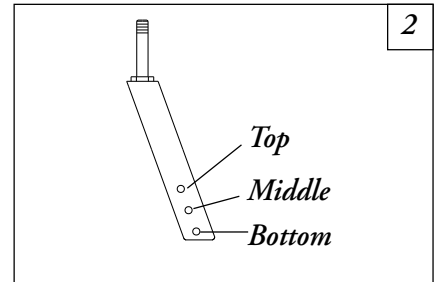
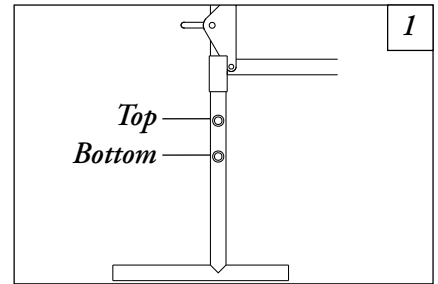

17 3/4	TOP	24 inch	TOP
19 3/4	BOTTOM	24 inch	BOTTOM

### **⚠ WARNING**

After ANY adjustments, repair or service and BEFORE use, make sure all attaching hardware is tightened securely – otherwise injury or damage may result.

#### **A. ANTI-TIPPERS**

### **⚠ WARNING**

The manufacturer strongly recommends ordering the anti-tippers as an additional safeguard for the wheelchair user.

### **⚠ WARNING**

Anti-tippers **MUST** be fully engaged. Ensure that the release button of the anti-tipper fully protrudes out of the hole on the bottom of the wheelchair frame.

### **⚠ WARNING**

Ensure both anti-tippers are adjusted to the same height.

#### **B. WHEEL LOCK ADJUSTMENT (FIGURE 1)**

**NOTE**– Before adjusting or replacing the wheel lock assemblies, ensure that the tires are inflated to the recommended psi on the sidewall of the tire.

1. Ensure the Wheel Lock (A) is in the open (unlocked) position.
2. Loosen the bolt and locknut (B) that secure the wheel lock assembly to the wheelchair frame (C).
3. Adjust the position of wheel lock until the measurement between the rear wheel (D) and the wheel lock shoe (E) is between 5/32 and 5/16 inches.
4. Securely tighten the bolt and locknut
5. Engage wheel lock and push against the wheelchair and determine if wheel lock engages the wheel lock shoe enough to hold the wheelchair.
6. Repeat the above procedures until the wheel lock holds the wheelchair.
7. Repeat STEPS 1-5 for the opposite wheel lock.
8. If 5/32 and 5/16-inches measurement can not be achieved, remove the bolt and locknut that secure the wheel lock to the wheelchair and mount the wheel lock in one of two mounting positions.
9. Repeat STEPS 1-6 until the wheel lock holds the wheelchair.

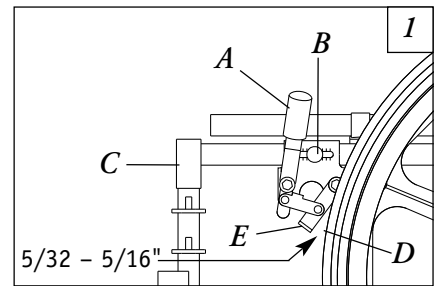

**A. 5 YEAR/LIFETIME LIMITED WARRANTY**

Sunrise warrants the frame and cross-brace of the 1000, 2000, 2000HD and 3000 Series wheelchairs against defects in materials and workmanship for five years to the original purchaser. Sunrise warrants the frame and cross-brace of the 4000 Series wheelchairs against defects in materials and workmanship for the lifetime of the wheelchair.

**B. FOR THREE YEARS**

Sunrise warrants the tires of the rear wheel of this wheelchair against defects in materials and workmanship for three years to the original purchaser.

**C. FOR NINETY DAYS**

Sunrise warrants the upholstery of this wheelchair against defects in materials and workmanship for 90 days to the original purchaser.

**D. FOR ONE YEAR**

Sunrise warrants all other parts and components of this wheelchair against defects in materials and workmanship for one year from the date of first consumer purchase.

**E. LIMITATIONS**

1. We do not warrant:
  - a. Damage from neglect, misuse, or from improper installation or repair.
  - b. Damage from exceeding weight limit listed on chair.
2. This warranty is VOID if the original chair serial number tag is removed or altered.
3. This warranty applies in the USA/Canada only. Check with your supplier to find out if international warranties apply.

**F. WHAT WE WILL DO**

Our sole liability is to repair or replace covered parts. This is the exclusive remedy for consequential damages.

**G. WHAT YOU MUST DO**

1. Obtain from us through an authorized supplier, while this warranty is in effect, prior approval for return or repair of covered parts.
2. Return the wheelchair or part(s), freight pre-paid, to: Sunrise Medical, 2660 Sarnen St., San Diego, CA 92154.
3. Pay the cost of labor to repair, remove or install parts.

**H. NOTICE TO CONSUMER**

1. If allowed by law, this warranty is in place of any other warranty (written or oral, express or implied, including a warranty of merchantability, or fitness for a particular purpose).
2. This warranty gives you certain legal rights. You may also have other rights that vary from state to state.

Record your serial number here for future reference:

Serial #: \_\_\_\_\_